

Strata[®] ***DK***

Digital Business Telephone Systems

**Digital Telephone
User Guide**

(includes LCD, Add-on Module, and Direct Station Selection Console)

Publication Information

Toshiba America Information Systems, Inc., Telecommunication Systems Division, reserves the right, without prior notice, to revise this information publication for any reason, including, but not limited to, utilization of new advances in the state of technical arts or to simply change the design of this document.

Further, Toshiba America Information Systems, Inc., Telecommunication Systems Division, also reserves the right, without prior notice, to make such changes in equipment design or components as engineering or manufacturing methods may warrant.

DKA-UG-DKTEL-VD
4016168

Version D.1, June 2000
Version D, August 1999
Version C.1, May 1999
Version C, April 1998
Version B, October 1997
Version A, September 1996

© Copyright 2000

Toshiba America Information Systems, Inc. Telecommunication Systems Division

All rights reserved. No part of this manual, covered by the copyrights hereon, may be reproduced in any form or by any means—graphic, electronic, or mechanical, including recording, taping, photocopying, or information retrieval systems—without express written permission of the publisher of this material.

Strata is a registered trademark of Toshiba Corporation.
Stratagy is a registered trademark of Toshiba America Information Systems, Inc.

Trademarks, registered trademarks, and service marks are the property of their respective owners.

Contents

Introduction

Organization.....	viii
How to Use This Guide.....	viii
Action/Response	x
Related Documents/Media.....	x

Chapter 1 – The Grand Tour

Digital Telephone Models.....	2
Buttons	4
Fixed Buttons.....	4
Flexible Buttons.....	6
LCD.....	9
LCD Buttons	9
LED Indicators	10
On-hook/Off-hook	11
Volume Controls	12

Chapter 2 – Features

Before You Begin	15
Automatic Line Selection	16
Ringing Line Preference	16
Signaling	16

Contents

Chapter 2 – Features

Quick Reference.....	17
Making an Internal Call.....	17
Making an Outside Call.....	17
Making an Outside Call to an ISDN Trunk.....	18
On-Hook Dialing.....	19
Answering Calls.....	19
Incoming Call Notification.....	20
Account Code Calls.....	20
Forced Account Codes (Verified/Non-Verified).....	20
Voluntary Account Codes (Verified/Non-Verified).....	21
Alarm Reset.....	22
Alert Signaling.....	22
Attendant Console Calling.....	23
Automatic Busy Redial (ABR).....	23
Automatic Callback (ACB).....	25
Automatic Hold.....	26
BGM Over Telephone Speakers.....	27
Call Forward.....	27
Call Forward Modes.....	28
Using Call Forward Buttons.....	29
Using Access Codes.....	29
LCD Telephones.....	29
Call Forward–All Calls.....	30
Call Forward–Busy.....	31
Call Forward–No Answer.....	31
Call Forward–Busy/No Answer.....	32
Call Forward–Fixed.....	33
Call Forward—External.....	34
Call Park Orbits.....	36
Call Park and Page.....	38
Call Pickup.....	40
[DN] Pickup.....	40
Directed Call Pickup.....	40
Group Pickup.....	41
Page/Internal Call Pickup.....	42
Call Transfer with Camp-on.....	42

Call Waiting	44
Conference Calls	45
Date/Time/Day Adjustment	46
Direct Inward System Access (DISA)	46
DISA Calls - Internal	46
DISA Calls - External	47
Direct Station Selection (DSS) Buttons (Hotline)	48
Do Not Disturb (DND)	48
Door Lock(s)	49
Door Phone(s)	50
DTMF Tone Dialing with * and #	52
Emergency Ringdown/Hotline Service	53
Group Listening	53
Handsfree Answerback	54
Handsfree Monitoring	55
ISDN Outgoing Calling	56
Subaddress	56
Message Waiting	57
Message Waiting Light on [PDN]	57
Message Waiting Light on [PhDN/MW]	59
Message Waiting Light on Another Telephone	59
Microphone Cut-Off	60
Off-hook Call Announce (OCA)	60
HS-OCA	62
SP-OCA	62
Override Calls	63
Busy Override	64
Do Not Disturb Override	64
Executive Override	64
Privacy Override	65
Toll Restriction Override	65
Page Announcements	66
All Call Page	66
Privacy On-Line	67
Privacy Release	67
Release and Answer	68
Saved Number Redial	68

Contents

Chapter 3 – LCD Operation

Speakerphone	69
Speed Dial	70
Speed Dial–Advanced Features	72
Feature Access Codes	72
Speed Dial Pause and Flash Storage	75
Speed Dial Number Linking	75
Chain Dialing Speed Dial Numbers	77
Timed Reminders	78
Tone/Pulse Dialing	80
Two (Tandem) CO Line Connection	80
[DN] Button	80
CO Buttons	81
Supervision	83
Voice Mail Integration	84
Message Mailbox	84
Message Retrieval	85
Call Forward to Voice Systems	87

Chapter 3 – LCD Operation

Control Buttons	90
Soft Keys	91
Soft Key Display	92
How to Use Soft Keys	92
Soft Key Prompts	95
Busy Lamp Field (BLF) Display	96
Caller ID/ANI/DNIS Information Mode	97
DNIS	97
ANI/Caller ID	97
Call Park Orbit List Display	99
Retrieve and Auto Dial Lost Calls	99
Messages, Memos, and Name Display	101
Messages	103
System Messages 60~64	104
System Messages 65~99	104
Station Messages	104
Message Notifications	107

Silent Messaging (Busy Station) 110
 Memos..... 111
 Speed Dial Memos..... 111
 Timed Reminders..... 113
 Name/Number Display 113

Chapter 4 – Full Duplex Speakerphone

Dip Switches 118
 Speech Training Mode..... 122
 Special Button Operation (Button 10)..... 123

Chapter 5 – Add-on Module/DSS Console

DADM 125
 DSS Console 127
 [DSS] Button..... 128
 Features 128
 Calling a Station 128
 Transfer to an Idle Station 128
 Call Transfer with Camp-on 129
 Call Answering (CO Line)..... 130
 Speed Dial..... 130
 Paging 131
 Call Forward Override ([DSS] Override)..... 131
 Night Transfer..... 131

Appendix A – Access Codes

CO Line Access Codes 133
 Feature Access Codes 134
 Paging Access Codes 134
 Speed Dial Access Codes..... 136

Contents

Chapter 5 – Add-on Module/DSS Console

Appendix B – Centrex Application

Flexible Directory Numbering	137
Centrex Feature Buttons	137
Ringing Repeat.....	138
Delayed Ringing	138

Appendix C – Button Labels

139

Appendix D – International Settings

145

Index

147

Introduction

This guide describes how to use the 2000-series digital telephones for Strata DK systems. Models covered in this user guide include digital telephones equipped with a Liquid Crystal Display (LCD) and/or speakerphone, as well as the full-duplex digital speakerphone. Also discussed are Digital Add-on Modules (DADMs) and the Direct Station Selection (DSS) Console. The Strata DK systems which support this equipment are:

- ◆ DK14
- ◆ DK16e/16
- ◆ DK40i/40
- ◆ DK424i/DK424/DK280 (Release 3.0 or higher)

Note This user guide incorporates the information in the Strata DK's *Liquid Crystal Display Digital Telephone User Guide* and the *Add-on Module and Direct Station Selection Console User Guide*. Those guides are discontinued.

Organization

- ◆ **Chapter 1 – The Grand Tour** provides an overview of the equipment, buttons, Light Emitting Diodes (LEDs), and LCDs.
- ◆ **Chapter 2 – Features** describes the available digital telephone features in alphabetical order. Detailed instructions on using each feature are covered.
- ◆ **Chapter 3 – LCD Operation** includes an explanation of the Control button and Soft Key operations. Features which are available only on the LCD digital telephone are presented alphabetically and include detailed LCD displays.
- ◆ **Chapter 4 – Full-duplex Speakerphone** describes the DADM and DSS console features and buttons.
- ◆ **Appendix A – Access Codes** provides instructions for programming a sequence of steps or access codes onto feature buttons. It includes CO Line Access Codes, Paging Group Codes, Feature Access Codes (User Programmable Buttons), and Speed Dial Access Codes.
- ◆ **Appendix B – Centrex Application** describes the Centrex features which may be available with your Strata DK system.
- ◆ **Appendix C – Button Labels** lists the feature button designations of the 2000-series digital telephone models.
- ◆ **Appendix D – International Settings** shows the proper DIP switch settings for various countries.

How to Use This Guide

We suggest that you read this entire guide and get acquainted with the Strata DK digital telephones and its features. Once you become acquainted with the basic features, you can use this guide in conjunction with the *Digital Telephone Quick Reference Guide*.

Conventions

Letters in [brackets] represent buttons which have Directory Numbers on them. For example:

Conventions	Description
Note	Elaborates specific items or references other information. Within some tables, general notes apply to the entire table and numbered notes apply to specific items.
Important!	<i>Calls attention to important instructions or information.</i>
CAUTION!	Advises you that hardware, software applications, or data could be damaged if the instructions are not followed closely.
WARNING!	Alerts you when the given task could cause personal injury or death.
[DN]	Represents any Directory Number button, also known as an extension or intercom number.
[PDN]	Represents any Primary Directory Number button (the extension number for the telephone).
[SDN]	Represents any Secondary appearance of a PDN. A PDN which appears on another telephone is considered an SDN.
[PhDN]	Represents any Phantom Directory Number button (an additional DN).
Arial Bold	Represents telephone buttons.
Plus (+)	Shows a multiple PC keyboard or phone button entry. Entries without spaces between them show a simultaneous entry. Example: Esc+Enter . Entries with spaces between them show a sequential entry. Example: # + 5.
Tilde (~)	Means “through.” Example: 350~640 Hz frequency range.
➤	Denotes the step in a one-step procedure.
➤	Denotes a procedure.
See Figure 10	Grey words within the printed text denote cross-references. In the electronic version of this document (Strata DK Library CD-ROM or FYI Internet download), cross-references appear in blue hypertext.

Action/Response

The left column gives you single or numbered steps that you need to perform a procedure.

The right column gives the immediate response to your action. This column also includes additional notes and comments.

Related Documents/Media

Note Some documents listed here may appear in different versions on the CD-ROM, FYI, or in print. To find the most current version, check the version/date in the Publication Information on the back of the document's title page.

Refer to the following documents for more information:

- ◆ **Digital Telephone Quick Reference Guide** provides a quick reference for frequently-used digital telephone features.
- ◆ **PC/Data Interface User Guide** explains all the procedures necessary to operate stand-alone data interface units in the data mode for printer sharing and modem pooling. Also covers connection to a PC with a Telephone Application Programming Interface (TAPI).
- ◆ **System Administrator Guide** gives instructions for the System Administrator to manage the system. Contains instructions for Station Relocation, System Speed Dial, and other features only activated by the System Administrator.

For authorized users, Internet site FYI (<http://fyi.tsd.toshiba.com>) contains all current Strata DK documentation and enables you to view, print, and download current publications.

This chapter familiarizes you with the controls and indicators located on your digital telephone. Understanding the function of the feature buttons and their associated LEDs will improve your efficiency in using the telephone and will help you take advantage of all of the benefits your telephone offers.

Toshiba digital telephones incorporate state-of-the-art telecommunications technology and provide a vast array of calling features. They are easy to operate, and all features are accessed with a feature button or a brief access code.

If your telephone is equipped with an LCD, information and feature prompting makes call handling more efficient and provides easy access to frequently-used features. Abbreviated feature prompts guide you through specific tasks.

In addition to the standard features, the LCD telephones provide Alphanumeric Messaging, Busy Lamp Field (BLF) Identification, Central Office (CO) Line Identification, Timed Reminders with Messaging, Speed Dial Memo Directory Dialing, User Name/Number, Call Duration, Date/Time of Day displays, and the ability to display names and telephone numbers of outside, incoming callers.

Telephones equipped with a speakerphone, enable you to make and receive outside and internal calls without lifting the handset.

Digital Telephone Models

Feature operations in this guide use the button designations for the 2000-series models.

The following telephone models belong to the 2000-series (see [Figure 1 on Page 3](#)):

- ◆ DKT2010-H (10-button model that enables users to answer internal calls without lifting the handset)
- ◆ DKT2010-SD (10-button model equipped with a LCD and a speakerphone which enables users to make and receive outside and internal calls without lifting the handset)
- ◆ DKT2020-S (20-button speakerphone model which enables users to make and receive outside and internal calls without lifting the handset)
- ◆ DKT2020-SD (20-button speakerphone model equipped with an LCD, and a speakerphone which enables users to make and receive outside and internal calls without lifting the handset).
- ◆ DKT2020-FDSP (20-button speakerphone model equipped with an LCD, a speakerphone, and a jack for an External Microphone).

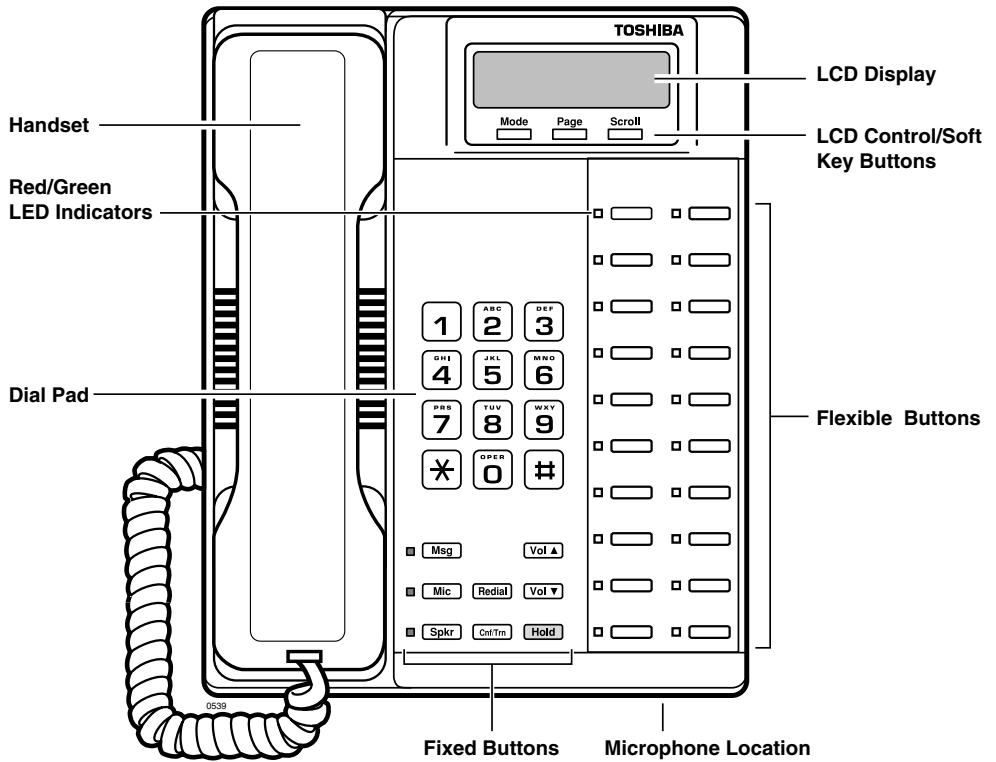

Figure 1 20-button Digital Speakerphone with LCD

Buttons

There are two sets of buttons, fixed and flexible. The fixed buttons (e.g., **Mic**, **Msg**, **Redial**, **Hold**, **Conf/Trn**, **Vol▲**, and **Vol▼**) are standard to every Strata DK 2000-series telephone (see [Table 1](#)). The flexible buttons consist of Directory Number (Primary, Secondary, Phantom) and feature buttons. The number of preprogrammed flexible buttons varies by telephone.

Fixed Buttons

The fixed buttons are located on your dial pad and enable you to perform standard functions quickly and easily.

Table 1 Fixed Button Definitions

Button	Definitions
<p>Cnf/Trn (Conference/ Transfer)</p>	<p>Press to set up conference and transfer calls (see “Conference Calls” on Page 45).</p>
<p>Hold</p>	<p>Press once to hold internal or outside calls. The Line LED flashes green at the internal hold rate.</p> <div data-bbox="947 787 1212 857" style="border: 1px solid black; padding: 2px; width: fit-content;"> <p>HOLD LINE 10 JAN 01 SUN 12:19</p> </div> <p>...or press twice to enable Exclusive Hold. The Line LED flashes green at the exclusive hold rate.</p> <p>Exclusive Hold enables you to place a call on hold so that only you or somebody using a Call Pickup code at another station can retrieve it.</p> <p>To retrieve a call on hold: Press Line or [DN] which is on hold</p> <p>...or if the call is on Exclusive Hold, from another station dial #5 plus your [DN], or dial #5#7 plus the CO line number (001~200) that the call is held on.</p> <p>If a call is not retrieved by a certain time (set in system programming), it recalls back to your phone. You hear repeated recall tone (or if you are on the phone, you hear recall tone twice).</p> <div data-bbox="947 1177 1212 1247" style="border: 1px solid black; padding: 2px; width: fit-content;"> <p>HOLD LINE 201 LINE 10 RECALL</p> </div>

Table 1 Fixed Button Definitions (continued)

Button	Definitions
<p>Hold (continued)</p>	<p>If the held party hangs up, the call is released and the CO provides a hold-release signal.</p> <p>If your telephone is programmed for Automatic Hold, existing calls are automatically placed on hold when you answer a call or make another call. (See “Automatic Hold” on Page 26.)</p> <p>A different call can be held on each [DN] or Line button on your phone. Each time you press Scroll, a different [DN] or Line is selected. The selected button’s LED flashes rapidly and your LCD displays information for the call holding on that button (samples shown at right).</p> <div style="display: flex; justify-content: space-around; align-items: center;"> <div style="border: 1px solid black; padding: 5px; text-align: center;"> <p>CO LINE 02</p> <p>HOLD</p> </div> <div style="border: 1px solid black; padding: 5px; text-align: center;"> <p>DN 202</p> <p>HOLD</p> </div> </div>
<p>Mic (Microphone)</p>	<p>Press to toggle the microphone ON/OFF while the telephone is in use. The LED indicates the status of the microphone.</p> <p>The microphone and accompanying LED are always ON when receiving “voice first” internal [DN] calls to enable Handsfree Answerback and OFF if you receive a ring-first call. Mic may be ON/OFF when placing an on-hook CO line or internal [DN] call.</p> <p>Each station’s Mic can be set in system programming to switch ON/OFF with one touch, to switch OFF only while pressed and held, or to be either ON/OFF at the start of handsfree dialing.</p> <p>To talkback to an HS-OCA call, press and hold Mic and talk over your telephone handset/headset. The LED and microphone remain OFF during OCA talkback operation (see “HS-OCA” on Page 62.)</p> <p>Mic functions on Handsfree Answerback and OCA calls for privacy.</p>
<p>Msg (Message)</p>	<p>When Msg LED flashes, press Msg to call back the station or voice mail device that activated the LED (see “Message Waiting” on Page 57.) This is the telephone’s [PDN] message waiting button.</p>
<p>Redial</p>	<p>Press the same [DN] or Line that you used to dial the original number. Press Redial. The last number called is redialed.</p> <p>If you have Automatic Line Selection, you must first lift the handset.</p>

Table 1 Fixed Button Definitions *(continued)*

Button	Definitions
<p style="text-align: center;">Spkr (Speaker)</p>	<p>Press to toggle the speaker ON/OFF. The LED indicates the status of the speaker.</p> <p>Spkr must be pressed and held down when switching from Handset to Speakerphone mode.</p> <p>Also selects a line or the internal [PDN] if programmed for auto preference in system programming. Can be used to disconnect on-hook speakerphone calls.</p>
<p style="text-align: center;">Vol▲ Vol▼</p>	<p>Press to adjust volume levels (see “Volume Controls” on Page 12).</p>

Flexible Buttons

All flexible buttons must be programmed for your telephone in system programming and vary for individual telephones. If a button does not appear on your display or telephone keystrip label, see your System Administrator for button assignments.

Line Buttons

You may have buttons designated as **Line** and/or **Pooled Line Grp** which enable you to directly access outside Central Office (CO) lines. **Pooled Line Grp** enables you to access available CO Lines from a group of lines appearing under one button.

If your telephone does not have a **Line** or **Pooled Line Grp** button and you want to access outside CO lines, you can use access codes. For a listing of these codes, see [“Access Codes” on Page 133](#).

Directory Number [DN] Buttons

The [DN] buttons consist of: [PDNs], [SDNs], and [PhDNs]. They are used to initiate or answer a call and are known as your extension or intercom number(s). You can have multiple [DN] buttons on your telephone (see [Figure 2](#)), including [DNs] belonging to another telephone, [SDNs].

Incoming calls ring your telephone's [PDNs] from the top down. For example, incoming calls to Station 10's [PDNs] first ring the "10-1" button, then "10-2," and finally "10-3." Your [PDN] is considered busy only when all of the [PDNs] are being used by your telephone or other telephones, and/or when your telephone is on any type of CO Line or [DN] call.

If you have an LCD telephone, you can find out the actual Directory Number of a [DN] button by pressing the [DN] you want to display and dialing **#407**. The number (**210**) displays.

DN = 210

Table 2 Directory Button Definitions

Button	Definitions
[PDN] Primary Directory Number	Press to answer a call to the Primary Directory Number or to initiate a phone call. The [PDN] is specifically your Extension Number or Intercom Number. Your telephone can have up to four [PDN] buttons with your number. You can set Call Forward and Voice Mail ID code for your [PDN].
[SDN] Secondary Directory Number	A [PDN] of another telephone which appears on your telephone is considered a [SDN]. You cannot set Call Forward and Voice Mail ID code for [SDNs] on your telephone.
[PhDN] Phantom Directory Number	Up to eight Phantom Directory Numbers can be dedicated to a station or shared by a group of stations. One example of a Phantom Directory Number application is when it is used as a common phone number for an entire department. For instance, when the [PhDN] appears on a group of telephones, such as the Sales Department, it will ring on all of the telephones of the group when it is called. You can only set Call Forward and Voice Mail ID code for [PhDNs] that are owned by your telephone. You can have a separate message waiting button and mailbox for up to four [PhDNs] on your telephone.

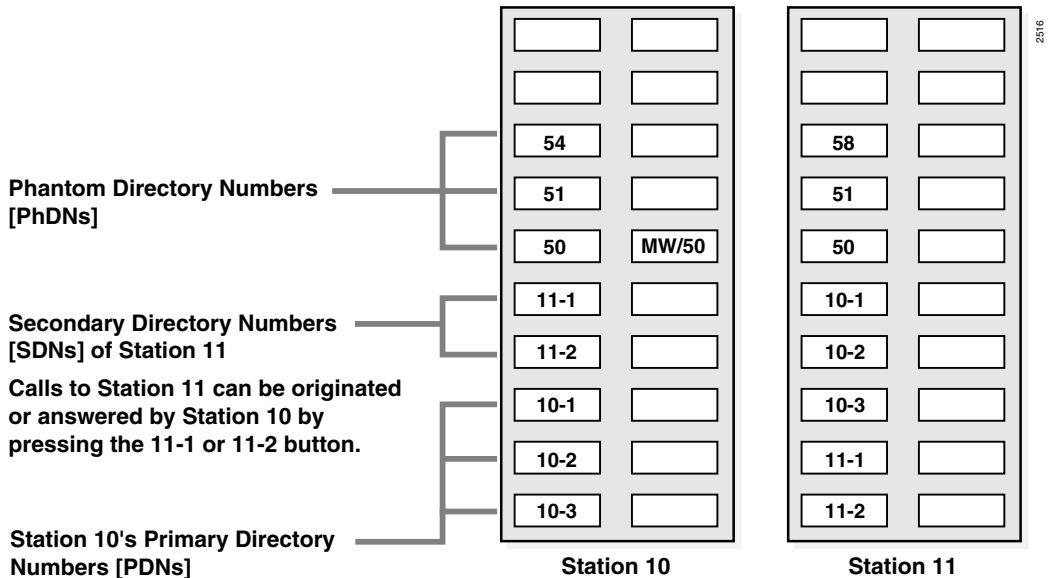

Figure 2 Multiple Directory Numbers Example

Feature Buttons

Preprogrammed feature buttons can be assigned to your telephone and vary for individual telephones. See [Table 18 on Page 139](#) for a list of all the possible feature buttons.

If a button does not appear on your display or telephone keypad label, see your System Administrator for button assignments.

If your telephone has not been programmed for a **Speed Dial** button, you can substitute the * key in any of the procedures that appear in this guide.

LCD

In its idle state, the 32-character LCD feature on your digital telephone gives you an accurate desk clock and calendar combination. When you have an outside call in progress, an elapsed time display gives a constant reminder of the call duration. Alphanumeric messaging capability is also provided (see “[Messages, Memos, and Name Display](#)” on Page 101). All display functions occur automatically as call processing proceeds.

A “+” next to the LCD readout (sample shown at right) on your telephone indicates there is more data in memory. Press **Scroll** to advance through the information. Press **Page** to switch from the CF display to the User Name display.

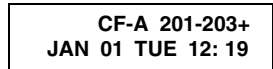

All LCD examples in this user guide are shown with Soft Keys turned OFF. If your telephone has Soft Keys turned ON, the displays may be different (e.g., the information on rows 1 and 2 is reversed), but they still enable you to follow the steps in this guide.

LCD Buttons

There are two sets of buttons available with the LCD, Control and Soft Key (see [Figure 3](#)). The Control buttons consist of the Mode, Page and Scroll functions, while the Soft Keys offer access to frequently-used features that appear as abbreviated prompts above the Control buttons.

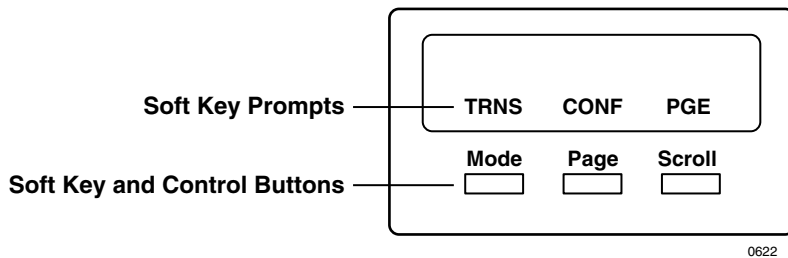

Figure 3 LCD Buttons (with sample Soft Keys)

Both sets of buttons cannot be active at the same time.

- ◆ Soft Keys are active when the Soft Keys are turned on and the telephone is active (on a call).
- ◆ Control buttons are active when the Soft Keys are turned off and/or the telephone is idle.

(See [Chapter 3 – LCD Operation](#) for an explanation of how to use these buttons.)

LED Indicators

Each line and feature button has a LED next to it which indicates the status of the line or feature associated with the button.

Line LEDs light red or green and flash at varying rates to indicate call status (see [Table 3](#)).

Table 3 LED Indicators

Use	Your Station (Green)	Other Station (Red)
	Interval Rates	
Line or [DN] In-Use (access outside line)	2 seconds on, 1/8 second off — 1/8 second ON/OFF	steady
Incoming Call (while ringing)	1 second on at 10 pulses/second —1 second OFF	one second ON/OFF
Hold (outside line) If using Pooled Line Grp , the hold indication is only at the station that places the call on hold.	4 pulses/second for 1/8 second ON/OFF	1/2 second ON/OFF
Hold – Consultation (during consultation/transfer to another station)	10 pulses/second	steady
Hold – Exclusive (outside line)	10 pulses/second	steady
Hold – Recall (when held call recalls your idle station)	1 second at 2 pulses/second, 1 second at 10 pulses/second	flashes

Table 3 LED Indicators *(continued)*

Use	Your Station (Green)	Other Station (Red)
	Interval Rates	
Hold – Exclusive Recall	1 second at 2 pulses/second, 1 second at 10 pulses/second	steady
Internal Call (while station ringing)	Your [PDN] flashes 10 pulses/second—1 second off	[SDN] red flashing or green ringing
Busy Station Transfer (outside call transferred to your busy station from a designated station or AA) After disconnecting first call...	4 pulses/second, 1/8 second ON/OFF	3/4 second on, 1/8 second OFF
	10 pulses/second	2 pulses/second
Alert Signal	.5 seconds	4 seconds
Conference	10 pulses/second	steady

On-hook/Off-hook

Some procedures in this user guide instruct you to perform a step while “on-hook” or “off-hook.” These terms refer to the position of the handset. “Off-hook” indicates that the handset should be lifted off of the telephone cradle. “On-hook” indicates that the handset should remain in the cradle and should not be lifted.

Volume Controls

Your telephone has a volume increase and decrease button for controlling speaker and handset volume levels.

You must hold down either button (**Vol ▲/Vol ▼**) for at least 1/8 second for any volume change to occur. If you continually hold down either button, the volume continually changes about every half second until the level limit is reached. You hear ring tone as long as you press a Volume button when your telephone is idle.

The method for changing feature volume varies. Some features can be adjusted using only the **Vol ▲/Vol ▼** (see [Table 4](#)) and others require additional buttons (see [Table 5 on Page 13](#)).

Table 4 Using only Vol ▲/Vol ▼

Feature	Phone Status	Comments
Ring Tone Volume/Incoming Handsfree Answerback and Speaker OCA	On-hook, Idle	Adjusting the ring tone volume also changes the volume level of incoming Handsfree Answerback and Speaker OCA calls before they are answered by pressing a [DN].
Handset Receiver	Off-hook	After a call is terminated and the handset is on-hook, the volume level returns to the “original” level for the next call. This “original” level can be adjusted to higher/lower in system programming.

Table 5 Using Vol ▲/Vol ▼ with Other Buttons

Feature	Phone Status	Press	Comments
Microphone Sensitivity	On-hook/ Off-hook	While pressing, hold Mic and Vol ▲/Vol ▼ for three seconds.	The Mic LED flashes about six times while setting the sensitivity. When the microphone is set for the lowest or normal sensitivity, the Mic LED lights steady when the telephone is busy on a speakerphone call.
Handset/Headset Call Waiting Tone	On-hook/ Off-hook	While pressing, hold Redial and Vol ▲	The tones are received over the handset/headset and speaker.
	On-hook/ Off-hook	While pressing, hold Redial and Vol ▼	The tones are received over the speaker.
Muted Tone Burst Tone sent for Busy or DND Override, Call Transfer with Camp-on, etc.	On-hook	[DN] followed by #6101 then Vol ▲/Vol ▼	You hear the muted tone for 15 seconds or until disconnected by pressing Spkr.
Ringing, Handsfree Answerback, and Speaker OCA.	On-hook	#6102 followed by Vol ▲/Vol ▼	Your phone rings for 15 seconds or until disconnected by pressing Spkr. Enables you to check if you can hear ringing at a distance from your telephone.
Speaker	On-hook, idle	[DN] followed by Vol ▲/Vol ▼	After you press a [DN], you hear dial tone. Adjusts Internal and CO Dial Tone, Background Music.

The Grand Tour

Volume Controls

This chapter lists all the digital telephone features in alphabetical order beginning on [Page 20](#). These features can be performed on 2000-series digital telephones equipped with or without LCDs. Features which require a telephone equipped with a speakerphone are noted.

Before You Begin

If you are a new user of the Strata DK digital telephone, you need to find out if your telephone has been set up for Automatic Line Selection and Ringing Line Preference. You will also need to know if your telephone has tone or voice first signaling when you receive an internal call:

- ◆ Tone Signaling rings.
- ◆ Voice First Signaling does not ring; instead you hear a long tone, then the caller's voice.

Each of these features are enabled in system programming and determine how you will make and answer calls on your telephone.

Features

Before You Begin

Automatic Line Selection

You *have* Automatic Line Selection, if you hear dial tone and the [DN], Line, or Pooled Line Grp LED lights steady green. The LCD displays the station number (**201**) and the seized CO line (sample shown at right).

NO. 201 USING LINE 11

- Lift the handset or press **Spkr**.

You do *not* have Automatic Line Selection, if you hear silence.

- Press an available [DN] or **Line** before dialing.

Ringing Line Preference

You *have* Ringing Line Preference, if you can answer a line ringing your station by lifting the handset or pressing **Spkr**. You do *not* have Ringing Line Preference, if you have to press the button associated with the ringing call (flashing LED) to answer the call.

If your telephone does not have Automatic Line Selection, press the flashing [DN] or **Line** first, before using the handset or **Spkr**.

Signaling

If you hear a long tone, followed by a caller's voice, you have *Voice* First Signaling.

- Talk in the direction of your telephone
...or answer the call as you normally would using either the handset or **Spkr**.

If you hear successive ring tones, you have *Tone* First Signaling.

- Lift the handset or press **Spkr**.

Note You can change to the alternate signaling method when making a call on a call-by-call basis by pressing **1** after dialing an internal telephone number.

Quick Reference

The following is a quick reference chart for using your telephone's standard features.

Making an Internal Call

1. Lift the handset or press **Spkr**
...or if you do not have Automatic Line Selection, press a [DN].
2. Dial a directory number (**201**).
3. When finished with the call, hang up or press **Spkr**.

NO. 203
201

Making an Outside Call

1. Lift the handset or press **Spkr**
...or if you do not have Automatic Line Selection, you must also:

NO. 203
USING LINE 6

press **Line**

...or **Pooled Line Grp**

...or [DN], then enter a CO line or line group access code (see [“CO Line Access Codes” on Page 133](#)).

2. Dial the telephone number.

The LED flashes green and the digits are displayed as you dial.

NO. 203 5551374

The display automatically changes from dialed number to elapsed time after a programmed period. After you hang up, elapsed time is displayed for 15 seconds and then changes to date/time display.

NO. 203 00: 13: 23

3. When finished with the call, hang up or press **Spkr**.

Making an Outside Call to an ISDN Trunk

1. Access an outside CO line
2. Dial the number.
3. Press **Start**.

The dialed digits will not be sent until you press this button or until the timer expires. See [“ISDN Outgoing Calling” on Page 56](#) for more information on ISDN calls.

On-Hook Dialing

1. Press **Spkr** (if you have Automatic line selection).
2. Access an outside line and dial a telephone number.
3. Lift the handset when the called party answers.
4. When finished with the call, hang up or press **Spkr**.

Note If you have a full speakerphone, you do not have to lift the handset.

Answering Calls

When you receive an incoming call, the LCD displays either the CO line (**10**)

NO. 203 LINE 10 RINGING

... or the station's [PDN] (**210**).

NO. 203 210 CALLING

- Lift the handset or press **Spkr**
...or if you do not have Ringing Line Preference, press the flashing [DN], **Line**, or **Pooled Line Grp** and lift the handset.

The green LED changes from incoming call rate to the in-use rate. Your LCD displays the answered line.

For information on Caller ID/ANI/DNIS LCD displays for incoming calls, see Chapter 3 – LCD Operation.

Features

Account Code Calls

Incoming Call Notification

Muted ringing while you are on a call indicates an incoming call. If another call comes in during the first call, release, transfer, or place the call on hold, then answer the second call.

- Press **Release and Ans**

...or hold down the hookswitch for about one second.

Account Code Calls

Entered before or after a call, Account Codes (i.e., Forced, Voluntary) can be used for a variety of reasons including billing, tracking, and line restriction applications. Account Codes are recorded by the system and can, along with the details of the calls, be printed on a Station Message Detail Recording (SMDR) report.

Forced Account Codes (Verified/Non-Verified)

Some applications require you enter an Account Code, called a Forced Account Code, before dialing a telephone number.

If the system is set for Verified Account Codes, station users must enter specific codes when entering the Forced Account Code(s) or the call does not execute. Verified Account Codes are established in system programming or by designated stations.

- **To dial using a Forced Account Code Emergency Override of Forced Account Codes**

You can bypass Forced Account Code requirements with three emergency numbers, including 911. See your System Administrator for these numbers:

- 1) 911
- 2) _____
- 3) _____

Voluntary Account Codes (Verified/Non-Verified)

Voluntary Account Codes are usually optional. They can be entered after accessing a CO line or during a call, to keep track of the call for client billing purposes.

An exception is a Voluntary Account Code which is required to change the Toll Restriction classification of your station. The code gives you access to telephone numbers outside your usual dialing area and must be entered prior to dialing the telephone number. As an example, if your station is restricted to local area calls, you can make out-of-state calls by using a Voluntary Account Code set in system programming.

If the system is set for Verified Account Codes, station users must enter specific codes when entering the Voluntary Account Code(s) or the code is not validated for the SMDR call report.

► To dial using a Voluntary Account Code

1. After accessing a CO line, press **Account Code**

...or **Speed Dial + 50**

...or ***50** if your telephone does not have a speed dial button.

2. Enter the Account Code.

Your conversation is not interrupted.

NO. 204
ENTER ACCT CODE

Note If the Voluntary Account Code is not required to dial out, the account code can be entered during a call.

When your station is set for Verified Account Codes, you hear a half second confirmation tone if the code is valid.

NO. 204
CODE VERIFIED

The outside party is not able to hear any tones (e.g., confirmation tones) when the Account Code digits are being entered. If your station is programmed not to verify Account Codes, you do not hear a confirmation tone.

Features

Alarm Reset

3. Dial another account code by repeating Steps 1 and 2.
4. Dial a telephone number.

If the code is invalid, you hear two short tones.

NO. 204
CODE NOT VALID

The last code entered is recorded.

Any digits dialed after the code is entered in Step 2 is treated as part of a telephone number.

Alarm Reset

Your Strata DK system can be connected to a facility alarm system. All telephones produce a startling tone whenever this alarm is activated.

- **To reset the alarm**
 - Press **Alarm Reset**.

Alert Signaling

Alert Signaling enables you to send an alert sound to a predesignated (partner) station by pressing a single button. This feature is based on the “buzz” key, where, for example, a manager might alert his/her administrative assistant to enter the office.

You can have as many as four **Alert Signal**(s) to send or receive an Alert Signal to/from other telephones. An Alert Signal is sent even if the alerted telephone is busy (on/off-hook) or in the DND or Call Forward mode.

- **To send an Alert Signal**
 - Press **Alert Signal**. An alert tone sounds at the designated station.

Attendant Console Calling

Up to four Attendant Consoles can be installed per system. There can be up to three ways to call the Attendant Console, depending upon system programming.

► To call any attendant console

- Press a [DN] + **0**.

The call rings the Attendant Console's **0** button. Dial **0** calls rotate between the consoles if more than one console is installed.

► To call a specific console

- Press a [DN] + the console's [DN].

The call rings the console's **In-DN** (incoming [DN] button). Your System Administrator can provide the Attendant Console(s) **In-DNs**.

► To call all consoles for an emergency

- Press a [DN] + the emergency access code **#400**.

The call rings the **Emgr** button on all attendant consoles.

Automatic Busy Redial (ABR)

After reaching a busy outside number, you can activate ABR so that the Strata DK system automatically redials the number at regular intervals. If the system redials an outside number that is still busy, ABR resets and tries again. This feature may not be allowed on some (or all) lines in your system—depending on the telephone line type connected.

ABR is not attempted while your station is busy, but continues to time-out. The system inserts a pause (**P**) on your LCD before redialing the number.

<p>NO. 202 P555 3700</p>
--

Features

Automatic Busy Redial (ABR)

► To activate ABR

1. When you reach a busy number, press **Auto Busy Redial** ...or **Cnf/Trn + #44**.

2. Hang up ...or press **Spkr**.

3. The system redials, up to 15 times, every 30 or 60 seconds (depending on system programming).

4. Your telephone receives ring tone, when ABR dials the number and it is available.

5. Lift the handset or press **Spkr** and wait for the party to answer.

The LED flashes red.

You hear confirmation tone.

NO. 202 ABR SET

The [DN] or Line and Spkr LEDs flash green.

If you do not pick up the handset or press **Spkr** within 30 seconds after a connection is made, you hear a muted ring for another 30 seconds, then the call disconnects.

► To cancel ABR

- Press **Auto Busy Redial** ...or [DN] + **#44**.

Automatic Callback (ACB)

After reaching a busy/DND station, you can set ACB to have the system call you back when the called station becomes available. You can also set ACB to place you in a queue for an available CO line, if you reach a line group in which all lines are busy.

► To set ACB

<p>1. After reaching either a busy/DND station or CO line, press Auto Callback ...or 4.</p>	<p>You hear busy tone, followed by dial tone (two secs.), then busy tone.</p> <p>When you set ACB at a busy station, its number (210) displays.</p> <p>When you set ACB at a busy line group, its access code number (801) is displayed.</p>	<p style="text-align: center;">NO. 204 INT 210 ACB SET</p>
<p>2. Hang up ...or press Spkr.</p>	<p>You can make other calls while waiting for the called station/line to become available.</p>	<p style="text-align: center;">NO. 204 INT 801 ACB SET</p>
<p>3. Your telephone rings at a fast rate when the called station or CO line becomes idle.</p>	<p>For busy/DND station: the [DN] LED flashes green (incoming call). The station number you called (210) displays.</p> <p>For busy CO line: the [DN] LED from which you attempted to first access the line flashes red (incoming call rate). The seized line's number (3) displays.</p>	<p style="text-align: center;">NO. 204 210 ACB</p>
		<p style="text-align: center;">NO. 204 LINE 3 ACB</p>

Features

Automatic Hold

4. Answer within three rings to prevent the callback from being cancelled.

After you answer, you hear a single tone, and the LED flashes green (in-use).

If you hear a busy tone after answering a callback, the called party is already on another call or the line has already been seized or has received an incoming call. Your request is not cancelled. You will be called again the next time a line becomes idle.

5. If you were attempting to make an outside call and did not use LCR, you must now redial the telephone number.

If the original call was made using LCR, the telephone number is automatically dialed.

➤ To cancel ACB (to busy or DND station)

- Press **Auto Callback** or [DN] + **#43**.

Automatic Hold

Automatic Hold enables you to automatically place a call on hold by pressing another outside **Line** or a [DN] button—there is no need to press **Hold**. You can also switch between calls without having to press **Hold**. Your telephone must be programmed for this feature, otherwise existing calls drop if you do not press **Hold** before answering or making another call.

➤ To use Automatic Hold

- While on a call, press another **Line** or [DN] to receive/originate a new call. The LED of the accessed line flashes (in-use). The first call is put on hold and the LED flashes (on-hold).

➤ To switch between calls

- Press **Line** or [DN] of the held call. The LED of the line just accessed flashes (in-use). The LED of the Line or [DN] placed on hold flashes (on-hold).

BGM Over Telephone Speakers

BGM over external speakers is controlled by the System Administrator. If BGM is enabled, you can turn it ON/OFF for your individual station speaker.

► To enable/cancel BGM on your telephone speaker

► Press **Tel Set Music** to toggle BGM ON/OFF.

...or press a [DN] + **#481 + Spkr** to turn BGM ON and press a [DN] + **#480 + Spkr** to turn it OFF (ignore busy tone after dialing **#481** and **#480**).

Call Forward

If your telephone has more than one [DN], you can assign Call Forward destinations for each [DN] on your telephone (up to one [PDN] and eight [PhDNs]). Each [DN] can be independently set for a different Call Forward feature. Call Forward must be set before the call is received and has priority over the Station Hunt feature.

To set call forward from a [PDN] or [PhDN]:

- ◆ You must set the call forward from your telephone.
- ◆ Your telephone must be programmed as the owner of the [PDN] or [PhDN].

Note If you hear a re-order tone when following any of the Call Forward steps, your telephone is not the owner of the [PDN]/[PhDN].

If Call Forward is set, the following calls to your station forward (except in Call Forward-External mode):

- ◆ Internal calls (Handsfree and OCA calls optionally may or may not)
- ◆ Auto Attendant calls
- ◆ CO lines calls that ring only your station
- ◆ Transferred CO line or station calls

CO lines that ring more than one station do not forward.

Call Forward Modes

You can set your telephone [PDNs] or [PhDNs] for a variety of Call Forward modes:

- ◆ **Call Forward—All Calls** forwards all calls immediately; your telephone does not ring when called.
- ◆ **Call Forward—Busy** forwards calls immediately when your station, [PDN], or [PhDN] is busy or in the DND mode.
 - ◆ On “tone-first” systems, if your [PDN] appears on more than one button on your telephone, Call Forward Busy forwards calls only when all [PDN] buttons are in use; if there is an idle [PDN], it flashes or rings when called.
 - ◆ On “voice-first” systems, Call Forward Busy forwards all calls any time your telephone is in use.

Note Call Forward-All Calls, Call Forward-Busy, Call Forward Busy-No Answer, and Call Forward-No Answer can be set with the touch of one button. See [“Feature Access Codes” on Page 73](#).

- ◆ **Call Forward—No Answer** forwards all calls to your station if you fail to answer within a designated time (set by you when you enable the feature). Your station can be programmed to bypass Call Forward-No Answer when receiving Voice First (handsfree) calls. Callers can activate voice first or OCA by dialing **1** during their voice announcement.
- ◆ **Call Forward—Busy/No Answer** forwards all calls to your station immediately whenever you are busy, in the DND mode, or after ringing and you do not answer the call within a designated time (set by you when you enable the feature). Your station can be programmed to bypass Call Forward/No Answer when receiving Voice First (handsfree) calls. Callers can activate ringing and Call Forward by dialing **1** during their voice announcement.
 - ◆ On “tone-first” systems, if your [PDN] appears on more than one button on your telephone, Call Forward Busy forwards calls only when all [PDN] buttons are in use; if there is an idle [PDN], it flashes or rings when called.
 - ◆ On “voice-first” systems, Call Forward Busy forwards all calls any time your telephone is in use and/or any time all of your [PDNs] are in use by other telephones.

- ◆ **Call Forward—Fixed** forwards immediately to a station or voice mail device set in system programming all internal, private or DID CO line calls to your station. Your station does not ring when called. Your station must be assigned with the **Call Forward to:** button in system programming to activate this feature.
- ◆ **Call Forward—External** forwards new incoming calls directed to your [PDN] to a destination outside of the system. [PhDNs] assigned to your telephone do not call forward to external destinations. Internal calls and transferred calls to your [PDN] also do not forward to external destinations.

Only incoming calls over CO lines dedicated to immediately ring your [PDN], the private CO **Line** button, and/or DID line, call forward externally. Any of the other Call Forward modes can be set for your [PDNs] or [PhDNs] simultaneously with Call Forward-External.

Using Call Forward Buttons

If your telephone has been system programmed for a Call Forward button, you can use one of the following Call Forward buttons to set the feature for a [PDN]: **Call Frwd All Calls, Call Frwd Busy, Call Frwd No Answer, Call Frwd Busy/NAAns, Call Forward External,** and **Call Forward to:** (Call Forward–Fixed feature).

Using Access Codes

If your telephone has not been programmed for Call Forward buttons or you are forwarding a [PhDN], you must use access codes to set the Call Forward feature.

LCD Telephones

The LCD on your telephone provides you with call forwarding information.

Make CF Call

When you call a [DN] that is forwarded [203], the [DN] you called is shown first.

NO. 201 203

The display changes to the [DN] where your call forwarded (210).

NO. 201 210

Features

Call Forward

Receive CF Call

When a call is forwarded to your [DN] (**210**), the calling [DN] (**205**) is displayed on the left and the [DN] called is displayed on the right [203].

NO. 201 205 CALL 203

Note The LCD examples shown in the following sections are identical to those on your telephone's LCD. At times, the entries on the display will scroll off the LCD and only portions of the entries will remain.

Call Forward—All Calls

1. Press Call Frwd All Calls ...or [PDN]/[PhDN] + #601 .	The LED flashes red.	NO. 201 CALL FORWARD TO
2. Enter the destination [DN].	You hear confirmation tone after #601 is dialed.	NO. 201 CALL FORWARD TO 203
3. Press Call Frwd All Calls ...or Spkr (if access code used).	The LED lights steady red and calls forward to the stored directory number [203].	CF-A 201-203 JAN 01 TUE 12: 19

➤ To cancel a Call Forward—All Calls

- Press **Call Frwd All Calls + Spkr**
...or [PDN] + **#601 + Spkr**.

Call Forward–Busy

<p>1. Press Call Frwd Busy ...or [PDN]/[PhDN] + #602.</p>	<p>The LED flashes red. You hear confirmation tone after #602 is dialed.</p>	<p style="text-align: center;">NO. 201 CALL FORWARD TO</p>
<p>2. Enter the destination [DN].</p>		<p style="text-align: center;">NO. 201 CALL FORWARD TO 203</p>
<p>3. Press Call Frwd Busy ...or Spkr (if access code used).</p>	<p>The LED lights steady red and calls forward to the stored directory number [203].</p>	<p style="text-align: center;">CF-B 201-203 JAN 01 TUE 12: 19</p>

► To cancel a Call Forward–Busy

- Press **Call Frwd Busy + Spkr**
...or [PDN] + **#602 + Spkr**.

Call Forward–No Answer

<p>1. Press Call Frwd No Answer ...or [PDN]/[PhDN] + #603.</p>	<p>The LED flashes red. You hear confirmation tone after #603 is dialed.</p>	<p style="text-align: center;">NO. 201 CALL FORWARD TO</p>
<p>2. Enter the destination [DN].</p>		<p style="text-align: center;">NO. 201 ALL FORWARD TO 203</p>

Features

Call Forward

3. Press **Speed Dial**.

Note Skip this step, if you pressed **Call Frwd No Answer** in Step 1.

4. Enter the time delay (**08~60**) seconds.

Note Skip this step if you do not want to change the time.

5. Press **Call Frwd No Answer** ...or **Redial**, then **Spkr** (if access code was used in Step 1).

The pre-set time delay for calls forwarding is 12 seconds.

NO. 201
ALL FORWARD TO 203*

The LCD displays the amount of time entered (**16**).

NO. 201
FORWARD TO 203*16

The LED lights steady red and calls forward to the stored directory number [203].

CF-NA 201-203
JAN 01 TUE 12: 19

► To cancel a Call Forward—No Answer

- Press **Call Frwd No Answer + Spkr** ...or [PDN] + **#603 + Spkr**.

Call Forward—Busy/No Answer

1. Press **Call Frwd Busy/NAns** ...or [PDN]/[PhDN] + **#604**.

The LED flashes red. You hear confirmation tone after **#604** is dialed.

NO. 201
CALL FORWARD TO

2. Enter the destination [DN].

NO. 201
ALL FORWARD TO 203

3. Press **Speed Dial**.

Note Skip this step, if you pressed **Call Frwd Busy/NAAns** in Step 1.

4. Enter the time delay (**08~60**) seconds.

Note Skip this step, if you do not want to change the time.

5. Press **Call Frwd No Answer**
...or **Redial**, then **Spkr** (if access code used in Step 1).

The pre-set time delay for calls to ring before forwarding is 12 seconds.

NO. 201
ALL FORWARD TO 203*

The LCD displays the amount of time entered (**16**).

NO. 201
L FORWARD TO 203*16

The LED lights steady red and calls forward to the stored directory number [203].

CF-BN 201-203
JAN 01 TUE 12: 19

➤ **To cancel a Call Forward—Busy/No Answer**

- Press **Call Frwd Busy/NAAns + Spkr**
...or [PDN] + **#604 + Spkr**.

Call Forward—Fixed

- Press **Call Frwd to:**. The LED lights steady red and all calls forward to a station [PDN] or voice mail device set in system programming.
...or press **Call Frwd to:** a second time to cancel the feature.

Call Forward—External

1. Store the destination number at Station Speed Dial location Code 49 (RCTUA, B, C/D processors) or location 139 (RCTUE/F processors).

Only perform Step 1 the first time Call Forward-External is set or when you change the destination. It is not necessary to store the destination each time; it remains in system memory.

2. To set CF-External, press **Call Frwd External**
...or the [PDN] + **#670**.

This feature enables you to forward new incoming calls directed to your [PDN] to a destination outside of the system. [PhDNs] assigned to your telephone do not Call Forward to an external destination. Internal calls and transferred calls to your [PDN] do not forward to external destinations.

Only incoming calls over CO lines dedicated to immediately ring on your [PDN], private **CO Line** button, and/or Direct In Dial line calls forward. Any of the other Call Forward modes can be set for your [PDNs] or [PhDNs] simultaneously with Call Forward-External.

Use the Speed Dial storage procedures detailed on [Page 70](#). When forwarding to an outside destination include the CO Line (or CO Line group) access code before the telephone number.

Example: 8015833700

801 = CO Line access code
5833700 = Telephone number

See [Table 13 on Page 134](#) for CO Line/Line Group access codes. The LCR access code “9” cannot be used.

Incoming calls forward to the destination stored at Station Speed Dial Location 49.

► To cancel a Call Forward—External

- Press **Call Frwd External**
...or [PDN] + **#670** + **Spkr**.

Remote Destination Change

If Call Forward-External mode is set at your station, you can change the forwarding destination from a telephone outside of the system.

► To change the destination number

- | | |
|--|---|
| 1. Call into the DK system over a CO line programmed for the DISA feature. | You hear ringback tone signal, then internal dial tone for 10 seconds.
Try again if you hear busy tone. |
| 2. After you receive dial tone, press #670 then dial your [PDN]. | Note See the System Administrator for DISA telephone numbers.
You hear a confirmation tone.
If a number is not dialed, the system automatically makes the DISA CO line ring as a normal incoming call. Then, if the call is not answered within 15 seconds after the ringing starts, it disconnects. |
| 3. Enter the Remote Call Forward-External security code. | You hear a confirmation tone. See the System Administrator for the security code which is assigned to your telephone in system programming. |

Features

Call Park Orbits

4. Enter the new destination number. You can enter an internal number, Voice Mail number or, a CO line access code plus an external telephone number. With some systems, you can dial a line group code instead of a CO line number access code. ([Table 13 on Page 134](#) for access code information.)
5. Press **#**.

You hear a confirmation tone.

Call Park Orbits

The Call Park feature enables you to hold a call temporarily in an orbit (the area where the call is held). Anyone can retrieve the call from the orbit using the same or a different station. There are 20 General Park Orbits for the system and 1 Personal Park Orbit for each station.

Once you have parked a call in an orbit, you can:

- ◆ Hang up and retrieve the parked call at a later time
- ◆ Originate another call
- ◆ Access a voice paging device to announce the parked call for pickup from another station

If you park a call and it is not retrieved the following occurs:

- ◆ If your station is idle when the system Call Park recall timer expires, the parked call automatically recalls to your station.

- ◆ If your station is busy, the parked call camps-on.

If you have an LCD telephone, you can let the system automatically select an available orbit number which displays on your LCD. To monitor the calls parked at your station, see [“Call Park Orbit List Display”](#) on Page 99.

➤ **To park a call**

<p>1. While on a call, press Park in Orbit ...or Cnf/Trn + #332.</p>	<p>The LED flashes green (consultation-hold).</p>	<div style="border: 1px solid black; padding: 5px; width: fit-content; margin: auto;"> <p>ENTER ORBIT NO RTRN</p> </div>
<p>2. Enter a General Orbit Number (900~919) or a valid [PDN] ...or if you have an LCD, press 999.</p>	<p>The call is parked and the CO line flashes (Hold), or the [DN] LED turns OFF.</p> <p>The system parks the call on the lowest vacant Orbit Number.</p>	
<p>3. Hang up.</p>	<p>The caller’s extension or Line number and the orbit number are shown.</p>	<div style="border: 1px solid black; padding: 5px; width: fit-content; margin: auto;"> <p>6793 PK ORBIT 900</p> </div>
	<p>If the parked call is not retrieved within a specified time, the call rings back to your phone.</p>	<div style="border: 1px solid black; padding: 5px; width: fit-content; margin: auto;"> <p>LN 2 ORBIT 900</p> </div>
	<p>When a parked call recalls your phone, the LCD shows the line or [DN] that is recalling and the orbit number.</p>	<div style="border: 1px solid black; padding: 5px; width: fit-content; margin: auto;"> <p>L 2 PK ORBIT 900</p> </div>

Features

Call Park and Page

► To retrieve a parked call

1. Press **Park in Orbit**
...or [DN] + **#332**.
2. Enter the Orbit
Number where the
call is parked.

[DN] can be [PDN], [SDN] or [PhDN].

The [DN] LED flashes at the in-use rate when the call is retrieved.

Call Park and Page

You can use the Park feature in conjunction with the Page feature. This operation can be programmed on a **Speed Dial** button for one-touch activation (See [“Feature Access Codes” on Page 73.](#))

► To park and page a call

1. While on a call, press **Park and Page**
...or **Cnf/Trn** +
#331.
2. Enter a General Orbit
Number (**900~919**)
or a valid [PDN]
...or if you have an
LCD, press **999**.

The LED flashes green
(consultation-hold).

HOLD LINE 2 ENTER ORBIT NO.
--

The call is parked and the CO
line flashes (Hold), or the
[DN] LED turns OFF.

The system parks the call on the lowest vacant Orbit
Number.

3. Enter a [DN] or a Page Group or Zone access code (see [Tables 14](#) and [15](#) on [Page 135](#), respectively).

After you enter an Orbit Number, a short burst of dial tone prompts you to enter the Page access code.

The LCD shows the **999** Auto Park entry.

<p>HOLD LINE 2 999</p>
--

The LCD shows the Line being held and its orbit number. Example: Line **2** is held on orbit **900**.

<p>HOLD LINE 2 L 2 ORBIT 900</p>
--

4. Make your announcement (include the Orbit Number).
5. Hang up to free the paging device.

If the parked call is not retrieved within a specified time, the call rings back to your phone.

<p>PARK ORBIT 900 HOLD</p>
--

When a parked call recalls your phone, the LCD shows the line or [DN] that is recalling and the orbit number.

<p>L 2 PK ORBIT 900</p>

Call Pickup

You can pick up a call that is ringing another station's [PDN] or [PhDN], a call placed on hold at another station and other types of calls.

When you pick up an internal call, the calling station [200] displays on the left and the called station [201] displays on the right.

NO. 204 200 CALL 201

If your call is picked up by another station, the LCD shows that your call to station [200] was picked up by station [201].

NO. 204 200 PICKUP 201

[DN] Pickup

Picks up ringing or held Directory Numbers.

- Press [DN] + **#5#2** + [PDN] or [PhDN] that you want to pick up.

Directed Call Pickup

This feature enables you to pick up calls ringing in, or calls held at other stations.

➤ To use directed call pickup

1. Press **Directed Pickup**

...or [DN] + **#5**.

2. Dial directed [PDN].

The directed [PDN] is the Primary Directory Number of the station that has the ringing or held call that is to be picked up.

If more than one call is on hold, the call on the telephone's lowest button number is picked up. Ringing calls are picked up over held calls as a priority.

➤ **To pick up a ringing CO line in a tenant system**

- Press **Directed Pickup 1~4**
...or [DN] + **#59**.

You are connected to an incoming CO line call for a Tenant Group (1~4).

Notes

- In non-tenant systems, **Directed Pickup1** picks up any ringing CO line.
- This feature does not pickup held lines or transferred CO lines that are ringing; use Directed Call Pickup.

Group Pickup

Stations can be assigned in system programming to Pickup Groups. As many as 20 groups can be created to enable you to easily pick up incoming (new or transferred) or internal calls that are ringing stations that are in your group or in other groups. This feature does not pickup held calls. You may belong to more than one group. See your System Administrator for group assignments.

Calls Ringing Within Your Group

- Press **Group Pickup** or a [DN] + **#5#34**. You are connected to the call.

Calls Ringing to Other Groups

1. Press [DN].
2. Enter **#5**, then the access code (**#320~#339**) of the group to which the station belongs.

You hear dial tone.

You are connected to the call. If the called station belongs to more than one group, any of the Group Pickup codes associated with those groups pickup the call.

Features

Call Transfer with Camp-on

Page/Internal Call Pickup

This feature picks up Internal (station to station), Group Page, and All Call Page calls. If these types of calls occur at the same time, the pickup priority is station-to-station and then Page calls in the order of occurrence. In some systems this feature can be applied to pickup All Call Page exclusively.

► To pickup a page or internal call

- | | |
|-------------------------|---|
| 1. Press [DN]. | You hear dial tone. |
| 2. Enter #5#30 . | You are connected to the caller who originated the internal or page call. The page circuit is released. |

Call Transfer with Camp-on

You can transfer calls to idle or busy [DNs], Hunt Group Numbers, ACD Group [DNs], etc. You cannot transfer (or camp-on) to a station's [PDN] or [PhDn] if the station is in the DND mode, unless the station's [PDN] or [PhDN] appears on other stations.

► To transfer a call

- | | |
|--|---|
| 1. While on a call, press Cnf/Trn . | The Line or [DN] LED flashes green (conference rate). You hear internal dial tone. |
| 2. Dial the [DN] where the call will be transferred. | The CO line rings the called station. If you hear a single tone, you can then announce the call over the called telephone's speaker. (If you hear ringing tone, the call was made with Tone Signaling.) |
| 3. If the station is idle, announce the call and hang up | |

...or if the station is busy or does not answer, hang up

The Line LED flashes green (on-hold). If you transferred the call from a [DN], the [DN]'s LED turns off. The CO line or [DN] camps on to the called station and the called station receives a warning tone. The camped-on call rings when you hang up.

...or to reconnect to the transferred line before it is answered, press the flashing **Line** or [DN] + **#42**.

The Line LED is a steady red when the called station answers the transferred call.

<p>NO. 204 CAMP-ON 4</p>
--

If the call is not answered after a specified Recall time set in system programming, camp-on is cancelled and the transferred call rings back (when your station or [DN] is idle or sends two tone bursts if your telephone is busy).

<p>HOLD LINE 2 LN 2 RECALL 203</p>
--

The LCD shows the CO line number and the station number [203] where it was originally transferred.

Call Waiting

You can answer a call that is transferred to your station, even when your station is busy. When another call is camped onto your station, you hear two camp-on tone beeps and the [DN] or Line LED flashes red (on-hold).

If a call is sent to your station when busy, and your station does not have a [DN] or **Line** button available to receive the call, two camp-on tone beeps are sent to your telephone. You must disconnect or transfer the existing call to answer the waiting call.

► To answer a waiting call by placing the current call on-hold

► Press **Hold**

The existing call is placed on-hold. The camped-on line rings your station (the Line LED flashes green - incoming call).

...or if your telephone has the Auto Hold feature, just press the flashing [DN] or **Line**.

You are connected to the transferred call. The [DN] or Line LED flashes green (in-use).

Note See your System Administrator to find out if you have Auto Hold.

► To answer a waiting call by disconnecting or transferring the current call

► Hang up or transfer the existing call; the camped-on call rings your station

The existing call disconnects or transfers. The camped-on line rings your telephone and the Line LED flashes green (incoming call).

...or press the flashing [DN] or **Line**.

This disconnects the current call and connects you to the transferred call. The [DN] or Line LED flashes green (in-use).

Conference Calls

This feature enables you to add other parties to an existing call. (If you have an LCD telephone, you can use Soft Keys to make a conference call.) The following conferencing configurations are possible:

- ◆ up to two stations and two CO lines
- ◆ up to three stations and one CO line
- ◆ up to four stations

► To make a conference call

<ol style="list-style-type: none"> 1. While on a call, press Cnf/Trn. 2. Dial a [DN] or access a CO line and dial the telephone number. 3. When the called party answers, press Cnf/Trn. 4. Repeat the procedure to add other CO lines or [DNs], remembering not to try and exceed the allowed number. 	<p>You hear dial tone and the [DN] or Line LED flashes green (conference-rate).</p> <p>All parties are conferenced. If the second call was placed on a [DN] or CO line that appears on your telephone, the LED also flashes green at the in-use rate.</p>
--	---

Notes

- If you receive a busy tone or no answer, press **Cnf/Trn** to return to the original connection.
- The new station is not conferenced unless its user lifts the handset or presses a [DN] to answer.

Date/Time/Day Adjustment

This feature is performed from a designated station. See the *System Administrator Guide* for instructions.

Direct Inward System Access (DISA)

Outside callers with telephones that send Dual-tone Multi-frequency (DTMF) tones can call in on CO lines programmed for DISA and dial a [DN] or outgoing CO line without going through an attendant or operator. See the System Administrator for this number.

DISA Calls - Internal

1. From outside the system, dial the DISA CO line telephone number.	You hear a ringback tone signal, then an internal dial tone for 10 seconds. If you do not dial within 10 seconds, the system automatically causes the DISA CO line to ring a telephone or group of telephones designated in system programming. Then, if the call is not answered within 15 seconds after the ringing starts, it disconnects.
2. When you hear dial tone, dial a [DN].	You hear ring tone. When the station answers, you are connected. If the call is not answered after 6 rings or 24 seconds, (whichever comes first) you hear busy tone.
3. If you receive busy tone or want to dial another number while the station is still ringing, press *. Repeat Step 2.	To call another station after completing a DISA station call, the internal party must transfer you. Station and System Page cannot be accessed on DISA calls.

DISA Calls - External

- | | |
|--|---|
| 1. From outside the system, call the DISA CO line telephone number. | You hear a ringback tone signal, then an internal dial tone for 10 seconds.

If you do not dial within 10 seconds, the system automatically rings the DISA CO line as a normal incoming call. Then, if the call is not answered within 15 seconds after the ringing starts, it disconnects. |
| 2. When you hear dial tone, dial a CO line or CO line access code

...or dial a CO line or CO line access code and then a DISA security code. See Table 13 on Page 134 access codes. | You hear dial tone. If you do not hear dial tone, you must also dial a DISA security code.

You hear dial tone.

Note See the System Administrator for the DISA security code number. If the correct code is not entered, the call disconnects. |
| 3. When you hear dial tone, dial a telephone number. | If set in system programming, both parties hear a warning tone approximately 4, 10, or 20 minutes after the call was made. Press 0 to reset the timer each time the tone sounds (for an additional 4, 10, or 20 minutes). If you do not press 0 , the call disconnects approximately one minute after the tone. |

Direct Station Selection (DSS) Buttons (Hotline)

This optional feature enables you to use a **DSS** button to connect directly to another station's [PDN]. The DSS LED shows the status (idle/busy) of the station and/or the station's [PDN]. For example, a station's DSS button LED shows busy (light steady red) when the station is:

- ◆ busy on a call on any button or is in the DND mode.
- ◆ idle but all appearances of the station's [PDN] are in use by other stations.

► To connect directly to another station's [PDN]

1. When connected to a CO line or another station, press **DSS**.
2. Announce the call
...or transfer the call by hanging up or pressing **Release and Ans**.

The original party is put on-hold. You can call a station even if the DSS LED shows busy (steady red).

Note You can transfer the call to an idle or busy station.

Do Not Disturb (DND)

If your station is in the DND mode, internal, external and transferred calls do not ring your station and OCA calls are denied. You can continue to make calls while in the DND mode.

If your [PDN] or [PhDN] appears on other stations, calls to your [PDN] or [PhDN] flash on your station and flash or ring the other stations. This enables your calls to be answered at the other stations (or yours), even while your station is in the DND mode.

Your "alert partner" telephone can override DND and signal your telephone by pressing **Alert Signal**. Telephones with DND Override can also call and mute ring your telephone.

➤ **To activate/deactivate DND**

- Press **Do Not Disturb**. The LED lights steady red and DND mode is activated.
...or press it again to toggle the feature off.

Notes

- Calls forward from your station immediately while in the DND mode, if it is set for Call Forward-Busy or Call Forward-Busy/No Answer.
- If you press **Do Not Disturb** while a call is ringing, the ringing stops. The LED continues to flash.

Door Lock(s)

Your telephone may have up to five **Unlock Door** button(s), which enables you to unlock a door.

Door Lock Button	Location
Unlock Door 0	
Unlock Door 1	
Unlock Door 2	
Unlock Door 3	
Unlock Door 4	

➤ **To unlock a door**

- Press **Unlock Door**. The door unlocks for three or six seconds (set in system programming). The Unlock Door LED is lit while the door is unlocked.

Features

Door Phone(s)

Door Phone(s)

Door phones can be used to call digital/electronic telephones selected in system programming. When a door phone calls, you hear a distinctive ringing tone, one or five times (set in system programming). You can also call a door phone and monitor the surrounding area.

The number of possible door phones vary by Strata DK system, with up to 12 as the maximum for larger systems.

LCD telephones display the door phone ID when calls are made to/from door phones (e.g., door phone 1A). The ID enables you to know the door phone [DN]. For example, door phone 1A corresponds to Door Phone [DN] **#151**, 1B to **#152**, etc. Door phone IDs and the corresponding [DNs] are shown in [Table 6](#).

NO. 204 DOOR PHONE 1A

Table 6 Door Phone Lock IDs/Locations

Door Phone [DNs]	Door Phone ID	Location	Door Phone [DNs]	Door Phone ID	Location
#151	1A		#157	3A	
#152	1B		#158	3B	
#153	1C		#159	3C	
#154	2A		#161	4A	
#155	2B		#162	4B	
#156	2C		#163	4C	

► **To answer a door phone call**

1. Lift the handset.

If you lift the handset while the door phone is still ringing, the [DN] LED flashes green (in-use) and you are connected to the door phone.

2. If not connected yet, dial the door phone [DN].

If you have an LCD telephone, see [Table 6](#) for the [DN].

...or to pick up door phone calls ringing someone else's phone, press [DN] + **#5#30**.

Note **#5#30** access is a system option that may not be turned on for your system.

► **To call/monitor a door phone**

1. With the handset off-hook, press a [DN].

You hear dial tone and the LED flashes green (in-use).

2. Dial the [DN] for the desired door location.

If you have an LCD telephone, see [Table 6](#) for the [DN].

A two-way talk-path exists between your telephone and the called door phone. You can audibly monitor the area around the door phone.

Note Door phone [DNs] can be stored on **SD** buttons. See [“Feature Access Codes” on Page 72](#).

Features

DTMF Tone Dialing with * and

► To call from a door phone

- | | |
|---|--|
| <ol style="list-style-type: none">1. Press the door phone button and then release it.2. When answered, speak at a normal voice level in the direction of the door phone. | You hear a distinctive ringing tone—one or five times (set in system programming). |
|---|--|

DTMF Tone Dialing with * and

You may have to send * and # DTMF tones to some devices or services, such as a voice mail device or computer output service. DTMF tones are automatically enabled on stations with **Speed Dial**. If you do not have **Speed Dial**, you must first dial *, # to enable these tones.

This feature disables the Speed Dial feature during the call. Speed Dial is restored when you complete the call or place it on hold.

► To output * and # DTMF tones on a telephone without a **Speed Dial** button

- While on an outside call, press *, then #. You can now output * and #, DTMF tones, and digits 0~9 for the duration of the call. This procedure must be repeated on each call where you require such output.

Emergency Ringdown/Hotline Service

The Emergency Ringdown or Hotline Service feature enables standard telephones to automatically ring a designated extension by going off-hook. Digital telephones cannot perform this feature, but they can *receive* Emergency Ringdown or Hotline Service from standard telephones.

Emergency Ringdown is used in healthcare facilities, where it is used to assist callers who may not be able to complete a call by dialing. An example of an incoming Emergency Ringdown call is shown on the right. The calling [DN] and “Ringdown” displays whether soft keys are ON or OFF.

205 CALLING RINGDOWN

This same feature is also known as Hotline Service and is often used for telephones in hotel/motel lobbies.

Group Listening

This feature enables you to set your telephone so that you and people near your telephone can hear the called party over the speaker, but the called party can not hear you. You can alternate between parties as long as the handset is off-hook.

➤ To activate group listening

- While off-hook on a call, hold down **Spkr**. The Spkr LED lights red.

➤ To deactivate group listening

- Release **Spkr**. The Spkr LED turns OFF. You can talk to the party through the handset.

Handsfree Answerback

You can talk back to internal or incoming Tie Line calls without lifting the handset.

► To receive a handsfree internal call

1. You hear a single long tone, followed by the caller's voice.	The LED flashes green (incoming call). The Mic LED lights steady red, indicating your microphone is active. The Spkr LED flashes red.
2. Do not lift the handset; speak toward the telephone in a normal voice level.	If you have a speakerphone, you will have better performance if you press the called [DN] button first.

Notes

- A [DN] must be pressed (or the handset must be taken off-hook) to actually answer the call. This is necessary before transferring or placing an internal call on hold.
- You can press **Vol ▲** or **Vol ▼** to control the volume of the Handsfree Answerback caller's voice and ring tone. See Chapter 1—The Grand Tour for more information on volume control.

Handsfree Monitoring

Calls placed on hold by an outside party may be monitored handsfree. This feature frees you from having to hold the handset to your ear until the outside party returns to the call, enabling you to take care of other tasks in the meantime.

► To use handsfree monitoring

- | | |
|--|---|
| 1. While on an off-hook call, press and hold Spkr . | The Spkr LED lights red. |
| 2. Place the handset on-hook. | The Spkr LED stays on and you can hear the distant party through your telephone speaker. |
| 3. Release Spkr . | For privacy, press Mic to turn your telephone's microphone off. (Otherwise, your conversations may be picked up.) |
| 4. Lift the handset when the party returns. | Note Each station's Mic can be set in system programming to switch ON/OFF with one touch, to switch OFF only while pressed and held, or to be either ON/OFF at the start of handsfree dialing. See your System Administrator if you want the setting changed. |

ISDN Outgoing Calling

This feature enables you to make outgoing call using an Integrated Services Digital Network (ISDN) trunk, provided that you are connected to a Strata DK424i, DK424 with software Release 4.0 or higher, or DK40i, and that you subscribe to ISDN lines. ISDN trunks offer faster call connection setup, and they also provide more connection circuits.

Making an ISDN outgoing call will either be handled automatically with a timer or by you initiating the ISDN “Start” sequence. The method depends on your system’s programming. See your System Administrator to determine the method.

► To make an outgoing call to an ISDN trunk

1. Access an outside CO line
2. Dial the number.
3. Press **Start**.

The dialed digits will not be sent until you press this button or until the timer expires.

Subaddress

Subaddress digits may be required for dialing another department, or to send a call to equipment, such as a printer. If you need to enter subaddress digits, follow these instructions:

► To make an outgoing call with a subaddress to an ISDN trunk

1. Access an outside CO line
2. Dial the number.
3. Press **Sub**.
4. Enter the subaddress.

The **Sub** button informs the system that the following digits are the subaddress.

5. Press **Start**.

The dialed digits will not be sent until you press this button or until the timer expires.

Message Waiting

If you call a busy station [DN] or its user does not answer, you can leave a message waiting indication at the station. The **Msg** LED at the called station flashes and the user can call you back by pressing the **Msg** button with the flashing LED. (Voice mail devices, as well as people, can leave message waiting indications.)

All telephones have a standard (fixed) **Msg** button/LED for receiving/retrieving messages left by callers that called the station's [PDN]. Telephones that own [PhDNs] can also have up to four additional (flexible) message waiting [PhDN/MW] buttons/LEDs for receiving/retrieving messages left by callers that called the respective [PhDNs]. To use the [PhDN] message waiting feature, your telephone needs to have [PhDN/MWs].

Up to four message waiting indications and LCD messages can be left at each [DN] or [PhDN] at one time. The fourth message and one of the LEDs is reserved for the Message Center.

Message Waiting Light on [PDN]

► To answer a Msg light

1. Press **Msg**, then lift the handset.

If you reach a station that is busy or does not answer, go on-hook and press **Msg** again. The system rotates to the next message sender.

Your phone rings the station or voice mail device that set the indication. The LED continues to flash red.

Features

Message Waiting

The LCD can show up to three stations that have left messages for the [PDN] and three for each of your [PhDNs].

2. Press **Scroll** to display them.
3. After receiving the message(s), place the handset on hook.

In the example (shown at right), the display indicates that station DN [203] received a message signal from DN [201]. The “+” indicates additional messages.

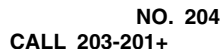

NO. 204
CALL 203-201+

If the Msg LED continues to flash, you have more messages—repeat the Steps to retrieve them. Voice mail devices may cancel the indication after a short delay.

► To cancel the Msg light

- Press **Msg** and lift the handset.

...or [DN] + **#409** to cancel the light. This must be done for each message recorded.

Your Msg LED turns OFF when the called party answers.

Note The called party must answer—by either going off-hook or by pressing **Spkr**—for the indication to be cancelled automatically.

Your Msg LED turns OFF without calling the telephone or VM device.

Message Waiting Light on [PhDN/MW]

► To respond to [PhDN/MW]

- | | |
|--|---|
| 1. Press the flashing red [PhDN/MW] LED. | Your phone rings the station or voice mail device that left the message. If the called party or VM device answers, the message waiting indication is cancelled automatically. If there is no answer, hang up and try at a later time. The red [PhDN/MW] LED on your phone continues to flash. |
| 2. After receiving the message, press Spkr ...or place the handset on-hook. | If you have more messages, the red [PhDN/MW] LED continues to flash. To answer the next message, repeat this procedure. |

► To cancel [PhDN/MW]

- | | |
|------------------------|---|
| 1. Press [PhDN]. | You hear a steady dial tone. |
| 2. Enter #409 . | The dial tone stops. |
| 3. Press Spkr . | The [PhDN/MW] LED turns OFF, indicating that the message has been canceled. |

Message Waiting Light on Another Telephone

► To set a message waiting light on another telephone

- | | |
|--|---|
| 1. Press [DN] and dial an internal number. | You hear ringback or busy tone. |
| 2. Press Msg or 7 . | The Msg or PhDN/MW] LED flashes red at the called telephone. The Msg LED lights steady red at your telephone. The LCD displays the station [203] where you set a message waiting light. |

NO. 201 INT 203 MW SET

Features

Microphone Cut-Off

3. Press **Spkr**.

The Msg LED on your telephone turns OFF. The Msg or [PhDN/MW] LED on the called telephone flashes until the called party presses the flashing **Msg** or [PhDN/MW].

SENT 203 JAN 01 SUN 12: 19

➤ To cancel a message light set on another station

- Press [DN] and dial **#64** plus the [PDN] or [PhDN] that has the message light set.

Microphone Cut-Off

This feature prevents callers from monitoring the sounds near your telephone when your telephone receives a Handsfree Call or cuts-off the telephone microphone while on a speakerphone call. When the feature is ON, the Microphn Cut-off LED lights steady red and the Mic and Spkr LEDs do not light when your telephone is called. When the feature is OFF, the Microphn Cut-off LED is not lit and your microphone works. The **Microphn Cut-off** functions on Handsfree Answerback and speaker OCA calls for privacy.

➤ To turn the microphone ON/OFF

- Press **Microphn Cut-off** to toggle between ON/OFF.

Off-hook Call Announce (OCA)

This feature enables you to call and speak through either the handset or the speaker of an off-hook, busy digital telephone. The called station must be set in system programming for this feature to work.

The calling station can be set in system programming for OCA to occur automatically when calling a busy-off-hook station or by dialing an access code after receiving busy tone. Automatic OCA only functions on Voice First Signaling systems. The following procedure covers both calling options.

- ◆ **Handset Off-hook Call Announce (HS-OCA)** – lets callers make an announcement through the handset (or headset). No special hardware is required.
- ◆ **Speaker Off-hook Call Announce (SP-OCA)** – lets callers make an announcement through the speaker of an off-hook, busy digital phone. The called telephone must be equipped with optional hardware.

When you receive an HS-OCA call while you are on another call, you hear a short warning tone (optional), followed by an announcement. You are the only one who hears the tone/announcement. The station [210] sending the HS-OCA is displayed on your LCD. Stations in the DND mode cannot receive OCA calls unless the calling station is programmed for DND Override.

NO. 204
210 BUSY OVRD

While on a speaker OCA call, **Mic** and **Microphn Cut-off** can be used to prevent an OCA caller from listening to your conversation with the original party (see “Microphone Cut-Off” on Page 60).

➤ **To make an OCA call (Voice First Signaling)**

- Lift the handset and dial the [DN]. You hear a single tone (optional) or nothing and can talk to the station (Automatic OCA).

Note If you receive busy tone, press **2** to OCA the station and talk. An optional tone is heard at the busy station, indicating that you are connected on an OCA call.

NO. 203
205 BUSY OVR

➤ **To make an OCA call (Tone Signaling)**

<p>1. Lift the handset and dial the [DN].</p> <p>2. If you hear busy tone, press 21 and speak to the called station</p> <p>...or if you hear a ring tone, press 12 and speak to the called station.</p>	<p>You may hear busy or ring tone.</p> <p>If you hear busy or ring tone after dialing the first digit (2 or 1), disregard the tone and dial the second digit to OCA the called telephone.</p> <p>If you still hear a busy tone after dialing 21 or 12, the called telephone is either busy on a speakerphone call or does not have the OCA option set in system programming. Either condition blocks OCA.</p>
---	---

Features

Off-hook Call Announce (OCA)

HS-OCA

➤ To answer an HS-OCA talkback call

- Press and hold **Mic**

This puts the original party on hold and you are connected to the HS-OCA call for as long as you press **Mic**.

When you release **Mic**, the HS-OCA party can not hear you, but you can still hear the original and HS-OCA parties.

...or **HS-OCA
Talkback.**

You are connected to the party that has sent the HS-OCA call. The original party is on hold.

Note Press the same button to toggle between parties.

HS-OCA Talkback acts as an ON/OFF switch between the two parties.

➤ To disconnect an HS-OCA call to your station

- Press **Spkr**. The HS-OCA call disconnects.

SP-OCA

➤ To answer an SP-OCA call

- Speak toward the microphone of your phone. You may want to hold your hand over the handset mouth piece to prevent the other party from hearing you.

➤ To disconnect an SP-OCA call to your station

- Press **Spkr**. The SP-OCA call made to your station disconnects.

Override Calls

The available override features are:

- ◆ **Busy Override (BOV)** – enables you to send a muted ring tone to a busy station to indicate that a call is waiting. The BOV muted ring can be programmed for each station to be two muted rings only or continued muted rings until the call is answered. This option applies to the station receiving the muted ring. The muted ring can be sent to the telephone speaker or to the telephone handset/headset and speaker.

- ◆ **Do Not Disturb Override** – lets you send a tone to an idle or busy station in the DND mode to indicate that a call is coming in. Your phone can also be programmed to block Do Not Disturb Override from other phones. Your station’s LCD shows the station you have called [210] is in the DND mode.

NO. 204
INT 210 DND

OCA is possible to DND stations from stations that are programmed for Do Not Disturb Override.

- ◆ **Executive Override** – enables you to enter an established conversation. Your phone can also be programmed to block Executive Override from other phones. The **Privacy on Line** does not block this feature.
- ◆ **Privacy Override** – enables you to enter an established call on a private common CO **Line** button; it will not operate on common [DNs] which are always private. (See “Conference Calls” which allow up to four parties to talk on a [DN] button.)

Up to two station users can enter an existing CO line-to-station call (i.e., up to three stations can be connected to a CO line). You can also use this feature if the station that is already connected to the CO line is in the Privacy Release mode. Station users with **Privacy Release** can allow stations to enter their conversations, even if the station entering the conversation is not programmed for Privacy Override.

Privacy Override is blocked by DND.

- ◆ **Toll Restriction Override** – Stations can be individually restricted from making toll calls. Each station can be allowed or denied specific area and office codes, long distance information calls, international calls and/or operator-assisted calls. You can completely override Toll Restriction at selected stations or you can

Features

Override Calls

change the station's Toll Restriction class. The station resumes its normal class at the conclusion of the call.

Busy Override

- After reaching a busy station, press **2**.

A muted tone is heard at the busy station, indicating that a call is waiting. The station number [**210**] displays.

NO. 203
210 BUSY OVR

Do Not Disturb Override

- After reaching a station in DND mode, press **2**.

A tone signal is heard at the DND station, indicating a call is coming in. On your station, the LCD shows the station number [**210**] you have overridden.

NO. 204
210 DND OVR

Your LCD displays **DND OVR DENY**, if the station you called denies Do Not Disturb Override.

NO. 204
DND OVR DENY

Executive Override

- After reaching a busy station, press **3**.

...or if you have an LCD phone, use the OVRD Soft Key. (See [“How to Use Soft Keys” on Page 92.](#))

You enter the conversation. The called parties may hear an optional tone signal prior to your entering the conversation.

The overridden station [**210**] displays until the call is ended.

NO. 204
210 EXEC OVRD

Your Station

The station initiating executive override [**204**] displays until the override is disconnected.

NO. 210 204 EXEC OVRD

Called Station

Privacy Override

- After reaching a busy station, press **Line**.

Connected parties may hear an optional tone signal before you are connected. Your station's LCD displays the CO line identification, **Line 03**.

NO. 204 LINE 03 PRV OVRD

The overridden station's LCD displays the initiating station's number [**204**].

NO. 205 204 PRV OVRD

Toll Restriction Override

1. Access a CO line.
2. Press **Cnf/Trn +#47**.
3. Enter the Toll Restriction Override Code (four digits).
4. Dial a telephone number.

You hear dial tone and the LED flashes at the in-use rate.

You no longer hear dial tone and your LCD prompts you to enter a code.

NO. 204 OVERRIDE CODE

You hear dial tone. For security reasons, the override codes are only available on a selected basis. See your System Administrator.

Page Announcements

Station users can make page announcements to telephones and external speakers.

► To make a page announcement

1. Press [DN], lift the handset, and enter a paging access code.
2. Use a normal voice level to make your announcement, then repeat it.
3. Hang up.

Note Each of the page access codes (including the [PDN] button) can be stored on an **SD** button. See [“Speed Dial–Advanced Features” on Page 72](#)

All Call Page

You can make an All Call Page to digital/electronic telephones assigned to the “All Call Page Group.” Stations are assigned to the “All Call Page Group” in system programming.

► To make an All Call Page

1. With the handset off-hook, press **All Call Page**
...or [DN] + **#39**.
2. Make your announcement in a normal voice level and repeat it.
3. Hang up.

The **All Call Page** button pages “All Call Page” telephones but does not access external page speakers.

Note **#39** may also Page external speakers as well as “All Call Page” telephones, depending on system programming.

Privacy On-Line

With this feature, you can block those with Privacy Override from entering your CO line. The button does not block Busy or Executive Override.

► To set/cancel privacy

- Press **Privacy on Line** to set privacy. The LED lights steady red. Others are blocked from entering your CO line calls when they press a common CO line button.

...or press **Privacy on Line** again to cancel the feature. The LED turns OFF.

Privacy Release

This feature enables others to enter your call on a common CO line just by pressing **Line** on their telephone. It only works on common CO lines (i.e., CO lines which appear on more than one telephone). Privacy Release cannot be used on single appearing CO lines or multiple [DN] buttons. Calls on common [DNs] are always private and cannot be accessed by more than one telephone.

Similar to conference calls, up to three stations can be connected to a CO line.

► To use Privacy Release

- While on a CO line call, press **Privacy Release**.

The LED lights red. The CO line flashes at all appearances. When another station user enters the CO call by pressing a common CO **Line**, the Privacy Release LED turns OFF.

To add a third station, press **Privacy Release** again and the process is repeated.

Release and Answer

This feature enables you to automatically disconnect or transfer an active call and answer a new call using a button, instead of a hookswitch. When you receive the new call, the LED flashes red and you hear a muted, Busy Override or Camp-on busy tone.

► To release an active call and answer an incoming call

- While on a call, you receive an incoming call. Press **Release and Ans**

...or **Cnf/Trn** and dial a “transfer to” destination. Then press **Release and Ans**

...or **DSS** of a “transfer to” destination, then press **Release and Ans**.

Releases the original call and answers the new incoming call.

Note You can press **Hold** before **Release and Ans** if you do not wish to release the original call.

Transfers the original call and answers the new call.

Transfers the original call and answers the new call.

Saved Number Redial

This feature enables you to store a dialed telephone or station number, then redial that number with the touch of a button.

► To save a telephone number

- While on a call that you dialed (busy, talking, or ringing), press **Save Last Number**.

➤ **To call a saved telephone number**

- Access a [DN] or CO line, then press **Save Last Number**. The system automatically dials the “saved” number.

Speakerphone

All digital telephone users can answer internal calls handsfree (on-hook), but only users with a speakerphone can make and receive calls without lifting the handset. Any digital telephone model with an “S” in the model name is equipped with a speakerphone.

➤ **To change from speakerphone to handset**

- Lift the handset.

➤ **To change from handset to speakerphone**

1. While on a call, press and hold **Spkr**.
2. Return the handset on-hook.
3. Release **Spkr**.

➤ **To make a call (on-hook dialing)**

- | | |
|--|--|
| <ol style="list-style-type: none"> 1. With the handset on-hook, access a CO line or press a [DN]. | <p>You hear dial tone and the Line or [DN] LED flashes green (in-use).</p> |
| <ol style="list-style-type: none"> 2. Dial a telephone number. | <p>You hear ringback tone (or busy tone, if busy).</p> |

Features

Speed Dial

3. Speak in a normal voice level toward the telephone.
4. Press **Spkr** to disconnect the call.

Note Your **Mic** button must be set to be ON at the start of a call in system programming. If not, you must press the **Mic** button before talking.

► To answer an incoming call using speakerphone

1. With the handset on-hook, press the **Line** or [DN] with the flashing LED.
2. Speak at a normal voice level toward the telephone.
3. Press **Spkr** to disconnect the call.

The Line or [DN] LED flashes green (in-use) and you are connected to the call.

Speed Dial

Speed Dial enables you to call a telephone number with a brief access code. There are two types of Speed Dial numbers:

- ◆ **Station** – assigned by individual station users to their own station and can only be dialed from the station that assigns it.
- ◆ **System** – only assigned from attendant consoles or a designated station (typically the System Administrator's station), and can be used by other stations. (See *System Administrator User Guide* for storing instructions.)

Important! *If you do not perform the following procedures within a specified time (set in system programming for either one or three minutes) when storing speed dial numbers, the operation times out and your telephone returns to idle mode.*

➤ **To store/replace a telephone number on a Station Speed Dial button**

1. With the handset on-hook, press **Redial**.
2. Press the **SD** you wish to store the telephone number on.

...or **Speed Dial** and enter the code that you want to store the telephone number in. See [Table 16 on Page 136](#) for codes.
3. Enter the telephone number (max. 20 digits).

To store longer dialing strings, see [“Speed Dial Number Linking” on Page 75](#).

To insert a pause or flash signal in the number, see [“Speed Dial Pause and Flash Storage” on Page 75](#).
4. Press **Redial**.

SD buttons are assigned in system programming.

The number is stored.

➤ **To clear a telephone number on a Station Speed Dial button**

- Repeat the previous procedure on [Page 71](#), skipping [Step 3](#).

➤ **To program one-touch telephone number dialing**

- Repeat the previous procedure on [Page 71](#), except for [Step 3](#). For [Step 3](#), press [PDN] + CO line access code before the telephone number. See [“CO Line Access Codes” on Page 133](#).

► To make a call using a Speed Dial button or access code

1. Lift the handset.
2. Access a CO line (if necessary).

If your **SD** button has been programmed to automatically do this, skip this step.

3. Press **SD**
...or **Speed Dial**.
Then enter a Speed Dial access code (see [Table 16 on Page 136](#)).

The system dials the telephone number assigned to the button/code. If your **SD** button is “one-touch,” as explained above, skip Step 1.

Speed Dial—Advanced Features

Feature Access Codes

You can program **SD** (Speed Dial) buttons with feature access codes for a single feature or a sequence of features as long as the keyed dial pad characters do not exceed 20 digits. To determine how many digits you have, count 2 digits for **Cnf/Trn**, [PDN] and **Hold** feature buttons and 1 digit for all other dial pad characters.

See [Table 7](#) for a list of feature access codes. Your System Administrator can tell you which features can be programmed on your telephone.

► To store a feature onto a **SD** button

- **Redial + SD + Feature Access Code + Redial**.
 - ◆ See [Table 7](#) for Feature Access code sequences.
 - ◆ **SD** = the speed dial button the feature is stored on.

➤ **To store a feature onto a code**

- **Redial + Speed Dial** + Speed Dial Access Code + Feature Access Code + **Redial**.

Important!

- Do not lift the handset.
- If you do not enter the entire sequence within a specified time (set in system programming for either one or three minutes), the operation times out and your telephone returns to idle mode.
- If your telephone does not have a **Speed Dial**, press “*” instead of Speed Dial, and enter **44** instead of # in all feature sequences
- [PDNs] can be stored in speed dial sequences but [PhDNs] and [SDNs] cannot.

Table 7 Feature Access Codes

Features	Feature Access Code Sequence
Account Code ¹ (Frequently used codes)	Cnf/Trn + #46 + Account code digits
Automatic Callback	4
Background Music ² (Telephone Speaker ON)	[PDN] + #481
Background Music ² (Telephone Speakers OFF)	[PDN] + #480
Call Forward—All Calls (To Station or VM)	[PDN] + #601 + Directory Number
Call Forward—Busy (To Station or VM)	[PDN] + #602 + Directory Number
Call Forward Cancel	[PDN] + #601
Call Forward—No Answer	[PDN] + #603
Call Forward External	[PDN] + #670
Call Forward External Cancel	[PDN] + #670
Door Phone Calling	[PDN] + door phone Directory Number
Hookflash Signal ¹	Cnf/Trn + #45
ISDN Sub	467
ISDN Start	469
ISDN Tone	490
Off-hook Call Announce (Manual Mode)	Voice First: 2 ; Tone First: 1, 2 1, or 1 2
One-touch Voice Mail Access	[PDN] + Voice Mail Directory Number

Features

Speed Dial—Advanced Features

Table 7 Feature Access Codes (continued)

Features	Feature Access Code Sequence
Outgoing Calls	[PDN] + CO line access code (See Table 13 on Page 134 .)
Overrides (Busy, DND)	2
Overrides (Executive)	3
Page Access ⁴	Hold + [PDN] + #XXX #XXX = Page Access code - “Paging Access Codes” on Pages 135 and 135 .
Park Call/Access Page The existing call is parked and you are automatically connected to the page.	Cnf/Trn + #331 + [X X X] + [Y Y Y] [X X X] ³ = 9 0 0~9 1 9 or 999 park zone number; [Y Y Y] = page group/zone (See Tables 14 and 15 on Page 135 .)
Pickup ⁴ (Directed to station, new, or transferred call)	Hold + [PDN] + #5 + station number [PDN]
Pickup a held or ringing [PDN] or [PhDN] (not available for all systems)	[PDN] + #5#2 + [X X X X] [X X X X] = [PDN] or [PhDN] to be picked up
Pickup ⁴ any ringing CO line (new call only)	Hold + [PDN] + #59
Pickup Station Page or Ringing Door Phone ⁴	Hold + [PDN] + #5#30
Pickup ⁴ External Page	Hold + [PDN] + #5#35
Pickup Line on Hold (lines 1~99) ⁵	[PDN] + #5 + #70(01~99)
Pickup Line on Hold (lines 100~200) ⁶	[PDN] + #5 + #7(100~200)

1. These codes can be used during a CO line call.
2. Background music speakers can only be turned ON/OFF from Station 200.
3. XXX = Auto Park Orbit 9 9 9 (access the next available park orbit), or General Park Zones 900~919, or [PDN] on which the call should be parked. Only use 999 with LCD telephones.
4. This feature will hold an existing call when the button is pressed. If the button is pressed when not on a call, pickup or page will still be accessed. These codes can be used during a CO line call.
5. After pressing the feature button, the user dials the line number (01~99) to pickup the line.
6. After pressing the feature number, the user dials the line number (100~200) to pickup the line.

Speed Dial Pause and Flash Storage

Some Speed Dial numbers may require a pause (long or regular) or hookflash be included (e.g., tone delay requires a pause at the beginning of a Speed Dial number).

Hookflash	Regular Pause	Long Pause
<p>The Flash button stores a flash signal only if Spd Dial Pause is programmed as a flexible button on the telephone. The flash signal is 0.5 or 2 seconds long (set in system programming) and is displayed on the LCD as “F”.</p> <p>Press Flash</p> <p>...or enter the hookflash dial code (Cnf/Trn + #45).</p>	<p>The pause is either 1.5 or 3 seconds (set in system programming). The LCD displays “P”.</p> <p>Press Spd Dial Pause</p> <p>...or if Spd Dial Pause is not on the telephone, press Flash to store a pause.</p>	<p>Ten-second pause, which can be entered anywhere in the Speed Dial number. The LCD displays “L”.</p> <p>Press Spd Dial Lng Pause.</p>

Speed Dial Number Linking

You can link any of the Station Speed Dial numbers to System Speed Dial codes or to any of the optional buttons associated with these codes. This enables up to 36 digits to be stored under one Station Speed Dial button or code.

The number directly stored in the System Speed Dial number dials out first, then the number linked to it. Typically, a company’s special carrier access telephone numbers are stored as part of the digit string.

Note A designated station can be used to link System Speed Dial codes. See the *System Administrator’s User Guide*.

Important! *Before linking Speed Dial Numbers, make sure the System Administrator has stored the desired number in the System Speed Dial you plan on using.*

Features

Speed Dial—Advanced Features

► To link station/system speed dial numbers

1. Press **Redial**.
2. Press **SD**
...or **Speed Dial** + a
Station Speed Dial Access
Code. (See [Table 17 on
Page 136.](#))
3. Press **Speed Dial**.
4. Enter the System
Speed Dial Access
Code to which the
number will be
linked. (See [Table 17
on Page 136.](#))
5. Enter the telephone
number to be stored
(max. 16 digits).
6. Press **Redial**.

The number is stored and is automatically dialed when the optional linked station **SD** button is pressed or the linked Station Speed Dial access code is dialed.

Linked Speed Dial Example

The System Administrator can store a CO line access code plus international long distance dialing codes in System Speed Dial locations (See [Table 17 on Page 136](#)). You link the System Speed Dial code to a telephone number stored in any Station Speed Dial location on your station.

System Administrator

Stores the CO line access code and the international dialing sequence (9011813) in the System Speed Dial location *690 from the administrator station.

- Press **Redial + Speed Dial + 690 + [PDN] + 9011813 + Redial**.

Note When you press [PDN], the letter “I” (Intercom) is displayed on your LCD. It is the [PDN] that is used to automatically access internal dial tone before dialing the remaining numbers in the Speed Dial sequence (in our example that number is 9011813).

where:

690 – System Speed Dial Code that is linked.

9 – CO line access code.

011 – international area code.

81 – country code (example: Japan)

3 – city code (example: Tokyo)

Station User

Stores the System Speed Dial information on Speed Dial Code 10.

➤ Press **Redial + Speed Dial + 10 + Speed Dial + 69058769374 + Redial**.

where:

10 – Station Speed Dial Code.

690 – System Speed Dial Code being linked to Speed Dial Code 10.

5876-9374 – local Tokyo telephone number.

➤ To use the new link

➤ From your station, press the **SD (10)** button or **Speed Dial + 10**. Your telephone automatically dials **9** to access a CO line, then the international dialing sequence code plus the local telephone number.

Chain Dialing Speed Dial Numbers

You can call two or more Speed Dial numbers during one call. This enables you to add additional parties (conference calls) to your conversation with Speed Dialing. It also allows dialing of a stored code, such as a credit card number, to send to a far-end computer.

Features

Timed Reminders

► To chain dial Speed Dial numbers

1. Access a CO line. (See [Table 13 on Page 134](#) for CO Line Access Codes.)
2. Press **Speed Dial** and dial the Speed Dial code for the telephone number to be dialed. (See [Table 16 on Page 136](#) for Speed Dial Codes.)
3. To dial another telephone number, press **Cnf** and repeat Steps 1 and 2.

Timed Reminders

You can set five separate reminders at your station. At the time (hour and minute) set by you, your telephone beeps. If your phone has an LCD, the message is also displayed. You can set the reminder to occur once or on a daily basis.

► To set a timed reminder

1. Press a [DN] and dial a timed reminder number (**#605-#609**).

#605 TIMER SET

2. Enter the time you want to be reminded.

Use a 24-hour clock format (HHMM).

#605 TIMER SET 0800

3. Press **0** for the reminder to be repeated every day, or **1** for a one-time reminder only.

#605 TIMER SET 08001

4. Enter desired LCD message station number (**10~19**) or system number (**60~99**)

...or enter **00** if your telephone does not have an LCD or if you do not want a message to display when the time reminder tone sounds.

605 TIMER SET 0800110

5. Press **Redial**.

The time is recorded in memory and you should hear a beeping tone (along with the displayed message) for 30 seconds at the set time.

DATA PROGRAMED

6. To cancel the beeping/message prior to 30 seconds, press **Mode + 0** or take the phone off-hook.

► To cancel a Timed Reminder

1. Press [DN], then the number of the timed reminder (**#605~#609**) you want to cancel.

You can only cancel one reminder at a time.

2. Press **Redial**.

The reminder is cancelled.

Tone/Pulse Dialing

With some older Central Offices, you may have to make calls on CO lines that are programmed for rotary dial pulses. This feature enables you, while on these lines, to switch to tone dial in order to access remote equipment (such as an answering machine) requiring DTMF tones.

With ISDN calls, when **Tone Dial Select** is pressed, all of the digits entered after that point will be sent with DTMF tones.

► To change Tone Dialing

1. Access a CO line.
2. Dial a telephone number.
3. While on the call, press **Tone Dial Select**.

Although the CO line is programmed for rotary dial pulses, access the CO line and dial the telephone number like any other call described in this user guide.

The Tone LED lights steady red and you are able to send DTMF tones with your dial pad. The feature is cancelled when the call is completed.

Two (Tandem) CO Line Connection

[DN] Button

This feature enables a station user to connect two CO lines, then drop out of the conversation.

► To connect two outside lines (using a [DN] button)

1. While talking on an outside call using a [DN] button, press **Cnf/Trn**.

You hear dial tone. The [DN] LED flashes (conference rate).

2. Dial a CO line access code and then the outside telephone number.

See [Table 13 on Page 134](#) or ask your System Administrator.

3. After the party answers, press **Cnf/Trn**.

The [DN] LED flashes (in-use rate) and all parties are conferenced.

If you receive a busy tone/no answer, press [DN] to return to the original connection.

4. Press **Cnf/Trn** and hang-up.

You hear dial tone before you hang-up. The [DN] LED flashes (exclusive-hold rate) and the two lines are connected. **N1** and **N2** identify the connected CO lines.

TRK-TRK N1 N2 JAN 10 THU 11: 57
--

The LED turns OFF when the parties hang-up.

If the public telephone company provides auto disconnect, the connection may release automatically when the parties hang up. If not, the lines must be supervised to be disconnected (see [“Supervision” on Page 83](#)).

CO Buttons

This feature allows a station user to connect two CO lines, then drop out of the conversation. On some systems, both CO **Line** buttons (or **Pooled Line Grp** buttons) must appear on your telephone to allow Tandem connections to be established from your telephone.

Features

Two (Tandem) CO Line Connection

► To connect two outside lines (using a **Line** button)

- | | |
|---|--|
| 1. Press CO Line
...or Pooled Line Grp and dial a telephone number. | You hear dial tone. |
| 2. After the party answers, press Cnf/Trn . | You hear dial tone. The CO Line LED flashes (conference rate). The new Line LED flashes (in-use rate). |
| 3. Press another CO Line
...or Pooled Line Grp and dial a telephone number. | |
| ...or on some systems, you can press Cnf/Trn and dial a CO line access code followed by a telephone number. | It is not necessary to have both CO Line buttons on your telephone. |
| 4. After the party answers, press Cnf/Trn .

If you receive a busy tone or no answer, return to the original connection by pressing the original Line button. | The Line LEDs both flash (in-use rate) and all parties are conferenced. |

5. Press **Cnf/Trn** and hang up.

You hear dial tone. Both Line LEDs continue to flash (exclusive-hold rate) and the two lines are connected. **N1** and **N2** identify the connected CO lines.

TRK-TRK N1 N2 JAN 10 THU 11: 57

The LED turns OFF when the parties hang-up.

If the public telephone company provides auto disconnect, the connection may release automatically when the parties hang up. If not, the lines must be supervised to be disconnected (see [“Supervision” on Page 83](#)).

Supervision

► To supervise a tandem call and release it

1. Press [DN]
...or **Line**
...or **Pooled Line Grp.**
2. If the parties have hung up, go back on-hook
...or if the parties are still talking, press **Cnf/Trn** and hang-up.

You are connected to both CO lines. Both Line LEDs flash (in-use rate). **N1** and **N2** identify the connected CO lines.

TRK-TRK N1 N2 JAN 10 THU 11: 57

Both Line LEDs turn OFF and the connection is released.

Voice Mail Integration

This section explains how to program your telephone for Call Forward and retrieve messages when using a Toshiba Voice Mail System with your Strata DK system. Refer to the appropriate Toshiba Voice Mail User Guide for more information:

- ◆ *Strategy Voice Processing User Guide*
- ◆ *Toshiba VP User Guide*

Message Mailbox

To direct forwarded calls to your mailbox—your personal storage space for voice messages—and to ensure that callers receive your personal greeting, you must store a Voice Mail (VM) Identification (ID) code. You need to store the ID code only once. Then whenever your station is call forwarded to voice mail, the VM ID code is automatically sent to the voice mail unit to direct the call to your mailbox.

Your [PDN] and up to four [PhDNs] can be independently Call Forwarded from your telephone to either a unique (or the same) mailbox number. Telephones must be programmed as the owners of a [PhDN] to be able to call forward the [PhDN] to a voice mailbox number.

► To assign a voice mail message mailbox number

Note This procedure is required for the initial storage of VM ID code to the Toshiba Voice Mail system. Once programmed, these digits remain in memory until changed. To change the code, repeat this procedure.

<p>1. Press [DN] + #656.</p>	<p>You hear confirmation tone.</p>	<div style="border: 1px solid black; padding: 5px; text-align: center;">656 ID CODE SET</div>
<p>2. Enter the voice mail ID code and the voice mailbox [DN], plus any required pauses (up to 16 characters).</p>	<p>Example: for Toshiba voice mail systems, enter 91 + the mailbox number.</p> <p>203= mailbox number of the [DN] you pressed in Step 1.</p>	<div style="border: 1px solid black; padding: 5px; text-align: center;">91203</div>

3. Press **Redial**.

You hear a confirmation tone. The LCD confirms the data storage.

DATA PROGRAMMED

➤ **To cancel the mailbox number**

- Press [DN] + **#656** + **Redial**.

Message Retrieval

You can program a flashing **MSG** or [PhDN/MW] to automatically retrieve your voice mail messages when it is pressed. Storing the message retrieval sequence in Steps 1~4 below is required only once. It remains in memory unless cancelled or changed.

➤ **To assign the message retrieval sequence**

1. Press [DN] + **#657**.

You hear a confirmation tone.

657 ID CODE SET

2. Enter the voice mail system code and the voice mailbox [DN], plus any required pauses (up to 16 characters).

Example: for Toshiba voice mail systems, enter **92** + the mailbox number.

92203

[203] = mailbox number.

3. Enter your security code.

By storing your security code, you avoid having to enter your code every time you access your mailbox; however, this will also allow anyone to retrieve your messages from your phone. If a security code is not desired, do not include it.

4. Press **Redial**.

You hear confirmation tone. The LCD confirms the data storage.

DATA PROGRAMMED

Features

Voice Mail Integration

- **To retrieve messages with **Msg** or [PhDN/MW] button**
 - Press **Msg** [PhDN/MW] button with flashing LED.
- **To cancel automatic retrieval**
 - Press [DN] + **#657** + **Redial**.

Multiple Message Retrieval (LCD Telephones)

1. With the flashing LED, press **Msg** or [PhDN/MW].

The displayed station is called.

When a message waiting voice mail is displayed, a **V** follows the station number. If a + sign is displayed, you have message waiting indications from more than one source (voice mail or stations). Press **Scroll** to rotate through more message waiting sources.

NO. 203 CALL 200 216V+

Call Forward to Voice Systems

By setting Call Forward to the Toshiba Voice Mail System on your telephone, callers are automatically connected to your voice mailbox.

Note **Call Forward** buttons can only be used to Call Forward [PDNs]; access codes can be used to Call Forward [PDNs] or [PhDNs].

► To forward calls to voice mail

- | | | | | | | | | | |
|--|--|-------------------------|-------------|--------------------|-------------|-------------------------|-------------|------------------------------|-------------|
| <p>1. Press the desired Call Forward button</p> <p>...or a [PDN] or [PhDN] + access code.</p> | <p>The LED flashes.</p> <p>You hear a confirmation tone after entering the access code.</p> <p>Call Forward access codes:</p> <table data-bbox="615 695 1122 829"> <tbody> <tr> <td>Call Forward-All Calls:</td> <td>#601</td> </tr> <tr> <td>Call Forward-Busy:</td> <td>#602</td> </tr> <tr> <td>Call Forward-No Answer:</td> <td>#603</td> </tr> <tr> <td>Call Forward-Busy-No Answer:</td> <td>#604</td> </tr> </tbody> </table> | Call Forward-All Calls: | #601 | Call Forward-Busy: | #602 | Call Forward-No Answer: | #603 | Call Forward-Busy-No Answer: | #604 |
| Call Forward-All Calls: | #601 | | | | | | | | |
| Call Forward-Busy: | #602 | | | | | | | | |
| Call Forward-No Answer: | #603 | | | | | | | | |
| Call Forward-Busy-No Answer: | #604 | | | | | | | | |
| <p>2. Dial the Voice Mail System Directory number _____.</p> | <p>See your System Administrator for the correct voice mail Directory Number. After dialing, you hear confirmation tone.</p> | | | | | | | | |
| <p>3. Press the same Call Forward button used in Step 1</p> <p>...or if you used an access code sequence, press Speed Dial + Redial + Spkr.</p> | <p>If your phone has a Call Forward button assigned, its LED lights steady red.</p> | | | | | | | | |

Features

Voice Mail Integration

► To cancel Call Forward

- Press Call Forward button

...or press a [PDN] or [PhDN] + **#601**, then hang up.

The Call Forward LED turns off.

Note Call Forward buttons apply only to [PDNs] and not to [PhDNs].

You hear a confirmation tone, and Call Forward is cancelled.

This chapter covers the LCD, its buttons and displays. Special features available only with the LCD are described in detail and step-by-step instructions on using them are given. (For digital telephone standard features, see [Chapter 2 – Features](#).)

Control Buttons

The **Mode**, **Page** and **Scroll** buttons are active when Soft Keys are turned off or your telephone is idle. [Table 8](#) lists button functions.

Table 8 Control Button Definitions

Button	Definitions
	Cancels the beeping tone when using timed reminders and enables you to enter/exit the following mode functions.
0	Used to exit another mode and return to clock/calendar display (see “To Exit from any Mode” on Page 91).
1	Busy Lamp Field (BLF) display (see “Busy Lamp Field (BLF) Display” on Page 96).
2	Busy station messaging (see “Silent Messaging (Busy Station)” on Page 110).
4	Called station messaging (see “Notification Station Messaging” on Page 107).
5	Displays LCD message number NN, where NN can be personal messages or system messages. Mode 5 only displays the selected message. It cannot be used to edit or create a new message.
8	Speed dial number check and memo dialing (see “Retrieve and Auto Dial Lost Calls” on Page 99).
60	Caller ID/ANI/DNIS information mode OFF (see “Caller ID/ANI/DNIS Information Mode” on Page 97).
61	Caller ID/ANI/DNIS information mode ON (see “Caller ID/ANI/DNIS Information Mode” on Page 97).
62	Caller ID/ANI/Lost Call stored information display (see “Retrieve and Auto Dial Lost Calls” on Page 99).
64	View Call Park Orbit list (see “Call Park Orbit List Display” on Page 99).
71	Soft Keys ON (see “Soft Keys” on Page 91).
70	Soft Keys OFF (see “Soft Keys” on Page 91).
94	Remote called station messaging (see “Group Notification Station Messaging” on Page 108).
95	Remote calling station messaging (see “To set a advisory station message for a remote station” on Page 106).

Table 8 Control Button Definitions (continued)

Button	Definitions
Page	<ul style="list-style-type: none"> ◆ Changes Busy Field groups. ◆ Changes displays (date/time, elapsed time, message, call forward, dialed number). ◆ Scrolls through speed dial numbers when in Mode 8.
Scroll	<ul style="list-style-type: none"> ◆ Scrolls through message waiting numbers. ◆ Scrolls through the speed dial digits (if more than 16 digits) when in Mode 8.

NO. 204
MAY 24 MON 12: 05

► To Exit from any Mode

1. Press **Mode**.

MODE NO. ?

2. Press **0**.

The LCD displays date/day/
time.

JUNE 03 TUE 03:54

Soft Keys

The Soft Key feature provides a quick-and-easy way to access frequently-used features during a call. When Soft Keys are on, they replace the Mode, Page, and Scroll functions. When your telephone is idle, Soft Keys do not display and the **Mode**, **Page**, and **Scroll** keys operate as LCD control buttons.

If the Soft Key feature is activated at your station, you can still access features with feature buttons (fixed or flexible) or with access codes. Your telephone may already come with the Soft Keys activated.

LCD Operation

Soft Keys

► To turn Soft Keys ON

1. Make sure that your telephone is idle and the handset on-hook.
2. Press **Mode + 71**.

Your LCD confirms that the keys are on.

LINE OR STATION?		
LINE	STA.	RTRN

► To turn Soft Keys OFF

1. Make sure that your telephone is idle and the handset on-hook.
2. Press **Mode + 70**.

Your LCD confirms that the keys are off.

NO. 204		
SOFT KEY OFF		

Soft Key Display

Abbreviated Soft Key feature prompts display on the LCD above the Control buttons (**Mode**, **Page**, and **Scroll**). In the following example, you would press **Mode** for the **TRNS** function, **Page** for **CONF** and **Scroll** for **PGE**.

TALK ON LINE 2		
TRNS	CONF	PGE

If the Soft Key feature is activated at your station, incoming call information does not display on your LCD while your station is busy. To display this information, you must either disconnect the existing call or place it on hold.

How to Use Soft Keys

This section provides an example of how to use Soft Keys to make a Conference call by adding a station to an outside call. See [“Soft Key Prompts” on Page 95](#) for a list of features that can be accessed with Soft Keys.

Example: Using Soft Keys to Make a Conference Call

While on an outside call (**LINE 3**) you initiated, your LCD displays the prompts **ABR**, **CONF**, and **PGE** during the first 30 seconds (if **ABR** does not appear, then this feature was not assigned in system programming).

TALK ON LINE 3		
ABR	CONF	PGE

Thirty seconds after the first digit of the telephone number is dialed, the display changes to **TRNS**, **CONF**, and **PGE**. If the call is an incoming call, the **TRNS** prompt appears immediately when you answer the call.

TALK ON LINE 3		
TRNS	CONF	PGE

► To Use Soft Keys to Make a Conference Call

1. While on an outside call, press **CONF** (**Page**) to initiate the Conference.

The outside call is placed on-hold.

LINE OR STATION?		
LINE	STA.	RTRN

(Optional) You can press **RTRN** (**Scroll**) to terminate the operation and return to the outside call.

If you press **RTRN**, you will have to repeat the previous step if you wish to return to transfer, conference, or page.

2. To transfer to a station, press **STA** (**Page**).
3. Dial a station number.

The name and/or number [203] displays for about three seconds.

DIAL STATION NO.		
RTRN		

CALLING		
JANE BROWN 203		

LCD Operation

Soft Keys

- | | | | |
|---|--|---|----------------------------------|
| | If you have Voice First Signaling, the display changes to: | <table border="1"><tr><td>ANNOUNCE TO 203
TRNS CONF PGE</td></tr></table> | ANNOUNCE TO 203
TRNS CONF PGE |
| ANNOUNCE TO 203
TRNS CONF PGE | | | |
| | If you have Tone First Signaling, the phone rings station [203] and the display changes to: | <table border="1"><tr><td>RINGING 203
TRNS TALK RTRN</td></tr></table> | RINGING 203
TRNS TALK RTRN |
| RINGING 203
TRNS TALK RTRN | | | |
| 4. (Optional) If you have voice first signaling, announce the call to station 203 . | The called station answers, and you are connected to station 203 and the outside call remains on-hold. | <table border="1"><tr><td>TALK WITH 203
TRNS JOIN RTRN</td></tr></table> | TALK WITH 203
TRNS JOIN RTRN |
| TALK WITH 203
TRNS JOIN RTRN | | | |
| 5. Press JOIN (Page) . | All parties are now joined in a conference. Your LCD indicates that you are in a conference with CO line 3 and station 203 [LN3+203]. | <table border="1"><tr><td>LN3+203
EXIT CONF</td></tr></table> | LN3+203
EXIT CONF |
| LN3+203
EXIT CONF | | | |
| 6. Press EXIT (Mode) to drop out of the conference

...or CONF (Page) to add another party to the conference. | The other parties remain connected in the conference call. | | |

Soft Key Prompts

Table 9 provides definitions of all of the Soft Key prompts that could appear on your LCD.

Table 9 Soft Key Prompts

Soft Key	Definition
ABR	Activates Automatic Busy Redial after dialing a busy outside telephone number.
ACB	Activates Automatic Callback after reaching a busy station, CO line, or CO Line group.
BUSY	(Busy Override) Sends a call-waiting tone to a busy station.
CONF	Initiates or completes a conference.
EXEC	(Executive Override) Breaks into the conversation of a busy called station.
EXIT	Exits you from a conference; remaining parties are connected.
JOIN	Joins all parties to a conference while on a conference call.
LINE	Adds a CO line to an existing call while in the Conference mode. The LCD prompts you to access a CO line after you press this key.
MESG	Sets a message waiting indication at a busy or unanswered station.
OVRD	Overrides options, busy mode, or overrides Do Not Disturb mode.
PGE	Parks an outside call and to gain access to a menu of options.
RING	Makes a called station ring when making a voice announce call to the station.
RLS	Disconnects a call and returns phone n to the idle state.
RTRN	Terminates a feature operation and to return to a previously displayed state.
STA.	Adds a station to an existing call while in the Conference mode. The LCD prompts you to dial a station number after you press this key.
TALK	Makes a voice announcement to a called station that is ringing.
TRNS	Initiates or completes a Transfer while on an outside call. Press once for an immediate or announced transfer, depending on system programming. Pressing TRNS again completes the transfer.

Busy Lamp Field (BLF) Display

This feature displays when a station is busy or ringing on any type of [DN] or CO line. If all or a telephone's [PDNs] are in use on another telephone(s), the telephone shows busy on the BLF, even though it may be idle. If a telephone is in the DND mode, the telephone BLF appearance displays busy.

Starting with the number entered, the BLF displays a group of 10 [PDNs] per line; a total of 20 for the LCD. Pressing **Page** scrolls the display. The BLF mode stops all other displays from appearing on your telephone's LCD.

► To display the BLF

1. Press **Mode + 1**.

BLF NO. ?

2. If [PDNs] are two digits, press **#**
...or enter the first digit of a three-digit [PDN]

For example, if you enter 2 for 200, the list of telephone [DNs] beginning with the **200** display. The sample LCD (shown at right) indicates that stations **200**, **205**, and **217** are in use or DND mode.

200 0 5
210 7

...or enter the first two digits of a four-digit [PDN].

3. Press **#**.
4. Press **Page** to rotate BLF groups.

The **200/210** group changes to **210/220**.

210 7
220 . . 2 . 4 9

Caller ID/ANI/DNIS Information Mode

Automatic Number Identification (ANI) information cannot co-exist on the same telephone LCD with Dialed Number Identification Service (DNIS) information. If your system is programmed to receive both ANI and DNIS information on incoming calls, press **Page** while the call is ringing to alternate between DNIS and ANI/Caller ID LCD displays. After you answer the call, you can not alternate between displays.

DNIS

Incoming DNIS telephone numbers can be correlated in the system database with assigned DNIS names. These names, up to 16 alphanumeric characters, display on your telephone's LCD, enabling incoming calls to be instantly identified and appropriately answered. [Table 10](#) shows DNIS samples.

ANI/Caller ID

If your telephone is programmed to receive Caller ID names and numbers, the calling party's name displays. [Table 10](#) shows ANI samples. If Caller ID was activated, then the caller's name and/or number would appear on the first line.

➤ To display the number while the call is ringing

- While the call is ringing, press **Page**.

MR. JONES LINE 3 RINGING

➤ To activate the Caller ID/ANI or DNIS display mode

- Press **Mode + 61**. (The system default is ON.)

➤ To deactivate the Caller ID/ANI or DNIS display mode

- Press **Mode + 60**.

LCD Operation

Caller ID/ANI/DNIS Information Mode

Table 10 DNIS/ANI Samples

Function	ANI/Caller ID Number ¹	DNIS/Caller ID Name
Incoming Call	CN: 7145556782 LINE 3 RINGING	TOSHIBA TSD LINE 3 CALLING
Incoming ACD Call		TOSHIBA TSD LINE 3 RINGING
Answered incoming or transferred call. Display changes to call duration.	CN: 7145556782 ANSWERED LINE 3	TOSHIBA TSD ANSWERED LINE 3
Call placed on-hold.	HOLD LINE 3 SEP 9 TUES 18:30	
Held call recalls your station.	CN: 7145556782 LINE 3 RECALL	TOSHIBA TSD LINE 3 RECALL
Station 201 is transferring a call to you (station 200).	NO. 200 201 CALLING	
Transferred station (201) hangs up.	CN: 7145556782 LN 3 TRANS 201	TOSHIBA TSD LINE 3 TRANS 201
Transferred call recalls your station (201).	CN: 7145556782 L 3 RECALL 201	TOSHIBA TSD L 3 RECALL 201
Call forwarded to your phone.		TOSHIBA TSD LINE 3 CALL 201

1. Caller ID numbers do not display **CN:** before the number, whereas ANI does.

Call Park Orbit List Display

This feature enables you to monitor (view) the calls that are parked at your station.

- ▶ While your phone is idle, press **Mode + 64**.

...or **Orbit List**. To scan the Orbit List, press **Scroll**.

LCD shows the CO Line number (**003**) and the orbit number where the call is parked (**900**).

LN 3 ORBIT 900+

Retrieve and Auto Dial Lost Calls

The system automatically saves the numbers for all calls that ring at your telephone, but are unanswered (lost calls). This feature enables you to view the stored information, view the time and date, delete the information without returning the call, and/or Auto Dial the saved numbers.

▶ To view lost calls

1. Press **Mode + 62**.

The phone number and caller name are displayed on your LCD. ANI/Caller ID numbers always include area codes.

MR. JONES
7145553700

2. Press **Scroll**

The next lost call displays.

MR. SMITH
7145568725

...or *****

The previous lost call displays.

MS. DOE
7143723546

LCD Operation

Retrieve and Auto Dial Lost Calls

...or **Page**.

Toggles between the phone number/caller name screen and the date and time screen.

06/02 17: 46
CN: 7145553700

MR. JONES
7145553700

Note **CN:** Identifies ANI calls as opposed to Caller ID calls which do not display **CN:**.

► To delete lost call

1. Press **Mode + 62**

The next lost call is displayed.

MR. SMITH
7145568725

2. Press **Scroll**

The next lost call displays.

...or press *****

The previous lost call displays.

MS. DOE
7143723546

...or press **#**.

The lost call information is deleted without auto dialing the call.

► To Auto Dial the lost call

1. Press **Mode + 62**

The phone number and caller name are displayed on your LCD. ANI/Caller ID numbers always include area codes.

MR. SMITH
7145568725

2. Press **Scroll**

The next lost call displays.

...or *****

The previous lost call displays.

MS. DOE
7143723546

3. Press **CO Line**
...or a [DN] + **CO Line** access code.

You hear dial tone.

4. Press **Lost Call Auto Dial**.

The DK System auto dials the digit “1” before dialing the saved, outgoing telephone number.

Messages, Memos, and Name Display

The LCD on your telephone can be used to send or receive messages to/from other LCD telephone users (sample shown at right). It can also display the names/numbers of the person calling your telephone or the name of the person you are calling. Names and memos can also be set to display with speed dial numbers and timed reminders.

**BACK AT 2-PM-CALL
MEETING FOR 3PM**

You can write or edit a station message (10~19), “fill in the blanks” of system messages 62~64, enter a name/title that will display when other stations call your station (see [“Name/Number Display” on Page 113](#)), or enter a Speed Dial (see [“Speed Dial Memos” on Page 111](#)) or Timed Reminder memo (see [“Timed Reminders” on Page 78](#)). System messages 65~99, if available, are written by the System Administrator and cannot be edited by the user.

LCD Operation

Messages, Memos, and Name Display

► To enter LCD characters

1. Access message/
memo/name display.
2. Enter the message/
name/memo (up to 32
alphanumeric
characters), using the
following dial pad keys
(dial pad shown at
right):
1 – moves right
***** – moves left
– toggles between
alphanumeric
mode (dial pad
defaults to
numeric mode)
0 – scrolls the alpha/
special characters.
3. To blank out any
portion of a message,
press **1** (in alpha mode)
and move the cursor to
the right.

A cursor (—) appears at the first character in the display.

See [Table 11](#) for dial pad key equivalents.

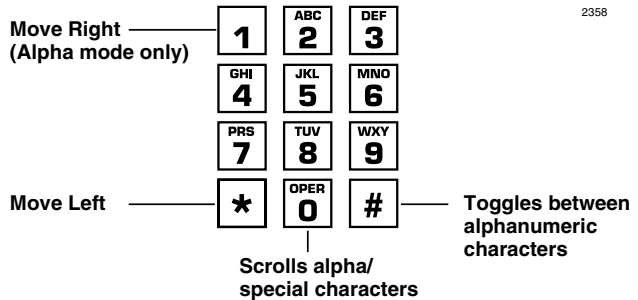

Each character the cursor transverses is deleted.

Table 11 Dial Pad Key Equivalentents

Letter	Key Equiv.	Letter	Key Equiv.	Letter	Key Equiv.	Symbol	Key Equiv.
A	2	J	5	S	700	:	1000
B	20	K	50	T	8	–	10000
C	200	L	500	U	80	+	100000
D	3	M	6	V	800	/	1000000
E	30	N	60	W	9	Note Symbols shown above must be made in alpha character mode on the dial pad.	
F	300	O	600	X	90		
G	4	P	7	Y	900		
H	40	Q	10	Z	100		
I	400	R	70				

Messages

There are three basic LCD message functions:

- ◆ **Advisory messaging** enables you to store an informative message for LCD telephones that call your phone.
- ◆ **Silent messaging** enables you to write a message that you can send to busy LCD telephones. Silent messaging lets you communicate visually to someone who is occupied on the telephone.
- ◆ **Notifications** enable you to send your station number and message indication to another LCD station. Responding to the message, the called station receives your message.

System Messages 60~64

System messages 60~64 are standard messages. You can “fill in the blanks” of messages 62~64 (see below). Example: Message 64 can be edited to read **RETURN ON JAN. 4**. Callers with LCD phones will see that message when they call your number.

System Message Number	Preprogrammed message (Max. 32 digits per message)
60	OUT TO LUNCH
61	IN A MEETING
62	CALL _____
63	BACK AT _____
64	RETURN ON _____

System Messages 65~99

System messages 65~99 can only be programmed or permanently changed at the Administrator’s telephone. Any messages programmed at Administrator’s telephone remain in memory until canceled from Administrator’s telephone or until the system is reinitialized.

Station Messages

You can create up to 10 station messages (10~19). Once entered, a message can never be deleted; only overwritten. This is a station option that is enabled in system programming.

► To enter/store a station message

1. Press **LCD Msg Select**

...or [PDN] + **#68**.

2. Enter the two-digit message number (10~19) to be stored.

The LCD Msg Select/[PDN] LED flashes.

MSG NO. ?

The current message, if any, is displayed.

3. Enter the message.
(See “To enter LCD characters” on Page 102.)
4. Repeat Steps 1~3 for any additional messages you want to store.
5. Press **LCD Msg Select**
...or **Spkr.**

The LCD Msg Select/[PDN] LED lights steadily, and the LCD displays the message. The message is now stored in system memory.

The message displays on your LCD an Advisory Message (see below). To cancel the message display, press [PDN] and dial **#68** or press **LCD Msg Select**.

➤ To set an advisory message for incoming calls

<ol style="list-style-type: none"> 1. Press LCD Msg Select ...or a [PDN] + #68. 	<p>The LCD Msg Select/[PDN] LED flashes.</p>	<div style="border: 1px solid black; padding: 5px; text-align: center;">MSG NO. ?</div>
<ol style="list-style-type: none"> 2. Enter the desired message number: 10~19 (station) ...or 60~99 (system) 	<p>The selected message displays. (This assumes the message has already been stored in memory.)</p>	<div style="border: 1px solid black; padding: 5px; text-align: center;">MSG NO. 10</div>
<ol style="list-style-type: none"> 3. Press LCD Msg Select ...or Spkr. 	<p>The message displays on your telephone’s LCD. The LCD Msg Select/[PDN] LED lights continuously. The selected message is sent to LCD phones when they call your [PDN] or any [PhDN] owned by the telephone.</p>	
<ol style="list-style-type: none"> 4. If you have Call Forward set, press Page to display the message instead of the CF display. 		

LCD Operation

Messages

➤ To cancel an advisory message that has been set at your station

- Press **LCD Msg Select**

...or [PDN] + **#68** + **Spkr.**

The LED goes out. If a station message was sent, this procedure does not erase it.

➤ To set a advisory station message for a remote station

1. While your telephone is idle, press Mode + 95 .		MODE 95 DEST EKT NO.?
2. Dial the destination [PDN].	207 = the destination [PDN]	MODE 95 DEST EKT EKT NO. 207
3. Press Page .		MW TO ST123 MSG NO?
4. Enter the message number (station 10~19 ; system, 60~99).	(This assumes the message is already stored in memory.)	MW TO STXXX MSG NO?10
5. Press Page .	Remote calling station messaging allows you to set a calling station message for only one station at a time.	
6. Press Mode .	207 = the [PDN] where message will be set. 010 = the message number. M = message is set.	CALL 207-010M Called station

7. Press **0**.

Your LCD shows the time and date. The message is displayed at station **207**. LCD telephones calling station **207** receives the message.



Your station

Message Notifications

With an LCD telephone, you can set short messages (up to 32 characters) that display to callers with LCD telephones.

Any station can record a message; however, only stations with an LCD are able to see the stored messages. Stations that do not use Soft Keys (Soft Keys Off: **Mode + 70**) can send messages “live” to other LCD station users.

Notification Station Messaging

Your station number and a message indication can be sent to another LCD station. When that station responds, it will receive the message. Soft Keys must be OFF at the sending station for this feature to operate.

► To set a notification station message

1. Press [PDN] and dial the station Directory Number (station does not answer or is busy).
2. Press **Mode + 4**.
3. Enter the message number.
4. Press **Msg**.

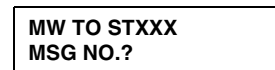

Station message (10~19), system message (60~99). The LCD displays the message. (This assumes the message has already been stored in memory.)

LCD Operation

Messages

5. Press **Spkr** or hang up to release.

Msg LED flashes on the called station.

204 = the called [DN]
207 = the [PDN] of the station that sent the message
M = message has been sent.

CALL 204-207M

Called station

SENT 204

Your station

➤ To receive a notification station message

- Press **Msg** when your telephone Msg LED is flashing.

➤ To cancel the message from the telephone that set the message

- Press [PDN] and dial **#64XXX**.

XXX is the [PDN] of the telephone that has the message set.

Group Notification Station Messaging

This feature enables a station to set a Called Station Message for a group of stations.

➤ To set a notification station message for another station or group of stations

1. Press **Mode + 94**.
2. Dial the destination [DN]
...or press **#30** for all call page stations,
...or enter a group code (**#31~#38**).

Station groups correspond to the same stations that are in respective Page groups assigned in system programming.

207=destination [DN] or group number.

#31~#38 for Page Group 1~8 respectively.

MODE 94
DEST EKT NO.?

MODE 94
DEST EKT NO. 207

3. Press Page .		MODE 94 ORG EKT NO.?
4. Dial the originating [PDN].	This can be your number or another station number.	MODE 94 ORG EKT NO. XXX
5. Press Page .		MSG NO.?
6. Enter the message number (station 10~19 ; system, 60~99).	The LCD displays the message. In this example, system message 60 was entered. (This assumes the message is already stored in memory.)	OUT TO LUNCH
7. Press Page .		MSG NO.?
8. Press Mode .		MODE NO.?
9. Press 0 .	At the destination station, the LCD displays the originating station number and the Msg LED flashes.	SENT 207M

➤ To receive a notification message

- Press **Msg**.

➤ **To cancel the message from the telephone that set the message**

- Press [PDN] and dial **#64XXX**, where XXX is the [PDN] of the telephone that set the message.

Silent Messaging (Busy Station)

An audible tone and an LCD message can be sent to an LCD station that is busy. The busy station can return a message to the calling station's LCD. The two stations may continue this procedure to carry on a "silent" conversation. Soft Keys must be OFF (**Mode + 7 0**) at the sending and receiving stations for this feature to operate.

➤ **To send a message to a busy station**

<p>1. When you receive a busy tone, press Mode + 2.</p>	<p>210=[DN]</p>	<div style="border: 1px solid black; padding: 5px; text-align: center;"> <p>OVER TO ST210 MSG NO?</p> </div>
<p>2. Enter the message number.</p>	<p>Station message (10~19) and system message (60~99). The LCD displays the message. (This assumes the message is already stored in memory.)</p>	
<p>3. Press Page.</p>	<p>The destination station beeps four times and the message displays for 30 seconds, or until you hang up.</p> <p>Your LCD confirms the message was sent.</p>	<div style="border: 1px solid black; padding: 5px; text-align: center;"> <p>MSG SEND</p> </div>

➤ To return to a busy station message after receiving a busy station message

1. Press Mode + 2 .	<div data-bbox="946 246 1210 315" style="border: 1px solid black; padding: 5px; text-align: center;">OVR TO ST210 MSG NO?</div>
2. Enter the message number.	<p>Station message (10~19) and system message (60~99). The LCD displays the message. (This assumes the message is already stored in memory.)</p>
3. Press Page .	<p>Your LCD confirms the message was sent.</p> <div data-bbox="946 545 1210 613" style="border: 1px solid black; padding: 5px; text-align: center;">MSG SEND</div>

Memos

Speed Dial Memos

You can store names (12 characters max.) for each of 40 station speed dial numbers. The memo pad of names can be scrolled to select the appropriate party. The station must be enabled via system programming for LCD message memory.

➤ To program Speed Dial names and numbers

1. Press Redial , then Speed Dial .	
2. Dial a station speed dial code.	<p>See Table 16 on Page 136 for speed dial codes.</p> <div data-bbox="946 1162 1210 1230" style="border: 1px solid black; padding: 5px; text-align: center;"># * 10 SPEED DIAL</div>
3. Press Mode .	<p>If a name was previously stored on this code, it appears on the top line.</p> <div data-bbox="946 1292 1210 1360" style="border: 1px solid black; padding: 5px; text-align: center;">*10 NAME SPEED DIAL</div>

LCD Operation

Memos

- | | |
|--|--|
| <ol style="list-style-type: none">4. Enter the name or memo (12 characters maximum).5. Press Mode.6. Enter a phone number (16 characters maximum).7. Press Redial to record data in memory. | <p>The name appears on the bottom line as you enter it. (See “To enter LCD characters” on Page 102.)</p> <p>The number displays on the top line as you enter it.</p> |
|--|--|

➤ To display the Speed Dial number and memo

- Press **Mode + 8X~X**, where X~X is the speed dial number to be displayed.

➤ To dial a Speed Dial number

- | | |
|---|------------------------------|
| <ol style="list-style-type: none">1. When your phone is idle, press Mode + 8.2. Enter Station Speed Dial Code
...or System Speed Dial Code.3. Press Page to see more of the directory of numbers/memos.4. Press an available Line
...or [DN] and enter a CO line access code. | <p>The number is dialed.</p> |
|---|------------------------------|

SPEED DIAL NO. 10

► To check a speed dial number

1. When phone is idle, press **Mode + 8**.

MODE NO.? 8

2. Dial a speed dial number.

TOSHIBA is the memo (up to 12 characters).

*11 TOSHIBA
7145553700

714 583 3700 is the number (up to 16 digits).

3. Press **Page** to scan the directory for the appropriate number/memo.

If the number is longer than 16 digits, a “+” appears in the far right corner of the display.

4. Press **Scroll** to display any remaining digits.

Timed Reminders

See “[Timed Reminders](#)” on Page 78.

Name/Number Display

This feature enables you to enter a name/title, telephone number, location, etc. in system memory. This name/title (e.g., LOBBY) displays on your station’s LCD while it is idle, and on other stations’ LCDs when you call them or they call you.

Name display information for non-LCD telephones or voice mail/auto attendant devices may be entered by the System Administrator for display on other stations’ LCDs when called.

When this feature is set, your Name/Number displays during direct, forwarded, and hunted calls. On override or OCA calls, it does not display.

LCD Operation

Name/Number Display

► To enter name/number information

1. Press [DN] + **#621**.

USER NAME ?

2. Enter the new information (up to 16 characters, e.g., user name and station number). See [“To enter LCD characters” on Page 102](#).

3. Press **Spkr**.

The information is stored and appears on the top line of your station's LCD.

TOSHIBA EXT. 200
DATE DAY TIME

When you call a station, the name/title displays on the bottom of the called station's LCD.

NO. 213
TOSHIBA EXT. 200

► To clear name/number display

1. Press [DN] + **#620**.
2. Press **Spkr**.

You hear confirmation tone, then busy tone.

During clear:

NO. 213
USER NAME RESET

After clear: A name is displaced by message and call forward settings if they are set.

NO. 213 DATE DAY TIME

Note This procedure does not erase the name/number. To restore the display, press [DN] + **#621**.

➤ **To erase name/number display**

1. Press [DN] + **#621**.

Current information displays on the lower line of the LCD.

USER NAME ?

2. Press **1** in the alpha mode to enter blanks.

Blank characters replace the information.

3. Press **Spkr**.

The information is erased and the [PDN] of the telephone is displayed.

LCD Operation

Name/Number Display

Full-duplex Speakerphone

4

This chapter explains how to use the Full-duplex Digital Speakerphone (DKT2020-FDSP).

The DKT2020-FDSP is designed to allow both parties of a speakerphone call to speak simultaneously. This eliminates “clipping” and enables true two-way conversation. However, when two parties are talking simultaneously, the performance is not as good as on a handset. The technology necessitates some volume loss in this situation.

An optional External Microphone can be connected for improved performance. However, the External Microphone is extremely directional and should only be used in certain applications. The telephone also provides half-duplex/full-duplex manual selection.

The DKT2020-FDSP has three operational modes for enhanced microphone use (Best, Good and Normal). These modes allow adjustments for different room acoustical characteristics. Choosing either the Internal or External Microphone (RFDM) and proper operational mode should be pre-selected by the system installer.

When the External Microphone option is installed, the telephone’s Internal Microphone is disabled on all but Voice First Handsfree Answerback calls and OCA calls. The External Microphone is powered by the phone (no batteries are required) and does not need to be turned off when not in use.

Choosing either the Internal or External Microphone is performed on the DIP switch 5, located under the keypad (see [Figure 4](#)).

Important!

The DKT2020-FDSP's full-duplex operation depends on the speaker volume setting. Raising or lowering speaker volume directly affects the performance of the full-duplex operation.

- ◆ *Depending on the room's echo characteristics, raising the volume of the speakerphone can cause the full-duplex operation to deteriorate. When set to maximum volume, it may be necessary to switch to half-duplex operation.*
- ◆ *The speakerphone will automatically reduce volume in each direction when both the FDSP user and the distant party are talking at the same time. The volume reduction is required to control the echoes at high volume levels. It is possible for surrounding conversations and other sounds to trigger this effect even when you are not speaking.*
- ◆ *The performance of the DKT2020-FDSP can vary on calls that involve a delay, such as wireless calls, Voice Over Internet Protocol calls, etc. With these types of calls, the quality can diminish.*
- ◆ *When using the [PDN] or Intercom button, the performance for internal calls is not as good as for external calls.*

Dip Switches

The DKT2020-FDSP has DIP switches that enable use for the External Microphone and the international market. The DIP switches are located underneath the flexible button key strip (see [Figure 4](#)).

There are three different DIP switch settings for optimum operation in various types of environments:

- ◆ **Best** – provides full-duplex operation with the Internal or External Microphone. This is ideal for a large enclosed area, such as an office with little echo. Echo varies according to the environment. For instance, a room that is relatively empty has more echo than a room with furniture or items that can absorb sound waves.
- ◆ **Good** – provides full-duplex operation with the Internal or External Microphone. This is ideal for a small office with high echo.
- ◆ **Normal** – provides full-duplex operation with the Internal or External Microphone. This works well with an open office area, such as an office cubicle.

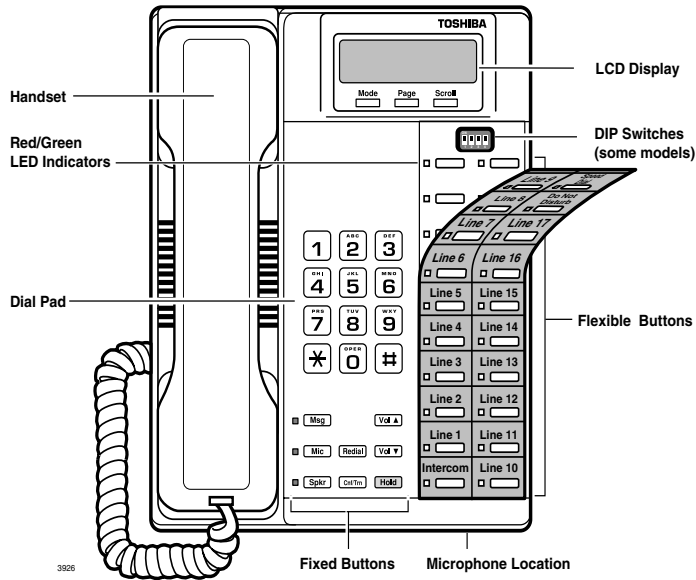

Figure 4 Location of DIP Switches

Table 12 shows the switch positions for the three different settings.

Table 12 DKT2020-FDSP DIP Switch Settings

Full Duplex Setting	Dip Switch							DIP Switch Position
	1	2	3	4	5	6	7	
Best	ON	ON	ON	ON	ON	OFF	ON	ON 1 2 3 4 5 6 7
Good	ON	ON	ON	ON	ON	ON	OFF	ON 1 2 3 4 5 6 7
Normal (Default)	ON	ON	ON	ON	ON	ON	ON	ON 1 2 3 4 5 6 7
Dip Switch 5 ON for Internal Microphone; OFF for External.								ON 1 2 3 4 5 6 7

5206

Full-duplex Speakerphone

Dip Switches

Note The first four DIP switches are used to select the country, same as all other DK2000-series telephones. The default DIP switch settings (1~4) are preset to On for the USA and Canada. If you need to make adjustments for other countries, see [Table 19 on Page 146](#).

► To use the External Microphone

1. Plug in the RFDm External Microphone into the bottom of the telephone (see [Figures 5 and 6](#)).
2. Turn the microphone On by opening it (see [Figure 7](#)).

Note The High/Low switch works independently from the telephone's speakerphone. This setting must be on High for proper operation.

Important!

- *The microphone has a narrow voice pick-up range so the front of the microphone should always point toward the person speaking (see [Figure 8](#)).*
- *Be sure to place the microphone at least one foot from the telephone speaker and do not point the microphone toward the telephone speaker grille.*
- *To use the external microphone in a conference room setting, place the microphone away from all parties to eliminate some of the directionality effect. Parties may have to speak up to be heard.*

CAUTION! Avoid pulling the microphone cord excessively.

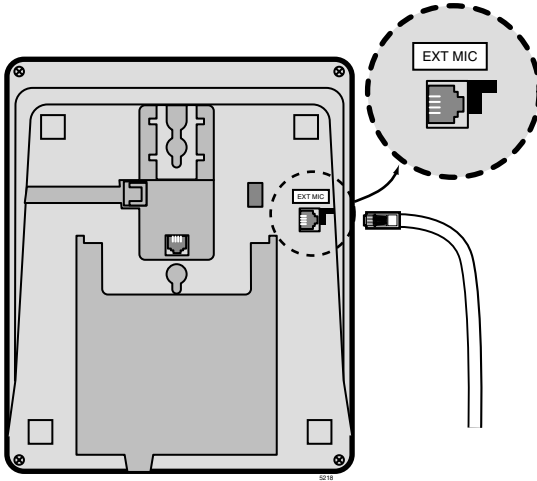

Figure 5 RFDM Plug on DKT2020-FDSP

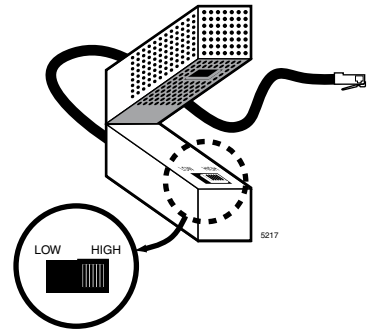
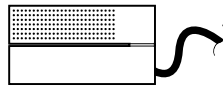
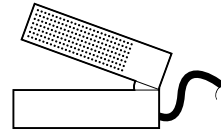

Figure 6 RFDM Unit



RFDM Unit (OFF Position)



RFDM Unit (ON Position)

5352

Figure 7 External Microphone On/Off

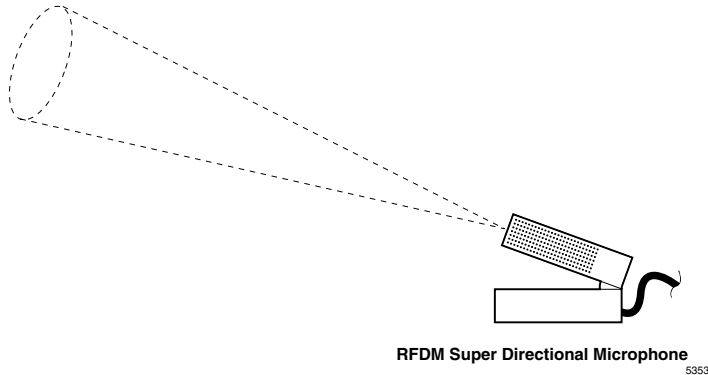

Figure 8 External Microphone Voice Pick-up Path

Speech Training Mode

When the DKT2020-FDSP is used in speakerphone mode, it adjusts to both the telephone line's and room's acoustic properties. At the beginning of each speakerphone call, the echo canceller must perform Speech Training by evaluating both the FDSP user and the far-end user's voice, background noise and line quality.

➤ To train the speakerphone

- The parties at both the local telephone and on the far end should take turns speaking for approximately 10 seconds.

➤ To improve speaker quality

- If the conversation becomes unstable during the call, or there is clipped speech, feedback or short silences, first try adjusting the volume. This forces the FDSP phone into speech training mode. The LED will go on.
- If conversation is still unstable, press button 10 to activate half-duplex mode. You can turn off button 10 at any time to reactivate full-duplex mode.

➤ **To force the telephone into Speech Training mode**

- During a call, momentarily press **Vol▲**, **Vol▼**, **Hold** or **MIC**.

During Speech Training mode, the speakerphone operates in half-duplex mode.

Tips for best results

- ◆ Avoid blocking the microphone or shuffling paper near the microphone.
- ◆ Avoid placing the speakerphone where it can detect excessive background noise, especially during Speech Training mode.
- ◆ Avoid moving the telephone during a call—this changes the room's acoustic properties. If the telephone or microphone is moved, you may have to force the Speech Training mode.

Special Button Operation (Button 10)

When using the external or Internal Microphone, button 10 works as a toggle from full- to half-duplex on the DKT2020-FDSP.

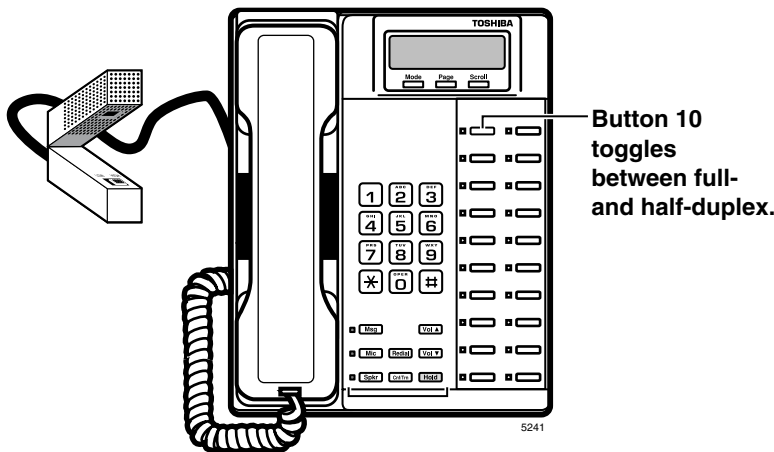

Figure 9 Button 10 on the Full-duplex Speakerphone

► To toggle full/half-duplex mode

- Press button 10 (see [Figure 9](#)) to turn full-duplex mode On or Off.

Full-duplex mode: Button 10 LED Off.

Half-duplex mode: Button 10 LED On.

Notes

- Button 10 functions the same for Internal and/or External Microphone.
- If DIP switch 6 and 7, in Figure 12, are turned Off, the Full/half-duplex function of Button 10 is disabled and Button 10 will function as programmed in Program 39 of system/station Programming.
- The DKT2020-FDSP's full-duplex operation depends on the speaker volume setting. Raising or lowering the speaker volume directly affects the performance of the full-duplex operation.

Important!

- ◆ *If raising or lowering the volume does not improve performance, switch to half-duplex mode by pressing Key 10.*
- ◆ *If both you and the distant party are using full-duplex speakerphones, the sensitivity to both echo paths may cause a reduction or instability of volume. If this happens, it may be necessary to switch to half-duplex mode by pressing key 10.*

This chapter provides an equipment overview of the following two optional units and describes the features buttons and their associated LEDs.

- ◆ **Digital Add-on Module (DADM)** – add 20 feature buttons to 2000-series digital telephones. Up to two DADMs can be connected to a telephone.
- ◆ **Direct Station Selection (DSS) Consoles** – available for system operators who do not have an attendant console. (See [“DSS Console” on Page 127.](#))

DADM

The DADM, model DADM2020, is shown in [Figure 10 on Page 126](#). The buttons can be programmed for [DSS], CO line access, and Station or System Speed Dial. Directory Numbers or other functions cannot be assigned to DADMs.

Each [DSS] and **Line** button has an LED that provides a status of the CO line or station assigned to it.

- ◆ The [DSS] LED flashes green when the station equipped with an DADM is calling or transferring an outside call to a station. (If calling a station, the LED turns steady red when the called station answers; if transferring to a station, the LED turns steady red when you hang up to complete the transfer.) The DSS LED is steady red whenever the station associated with the DSS is ringing, busy, or in the DND mode.

Add-on Module/DSS Console

DADM

- ◆ A Line (CO) LED is green when the CO line is in use by the DADM console user. It is red if it is in use by another telephone user.

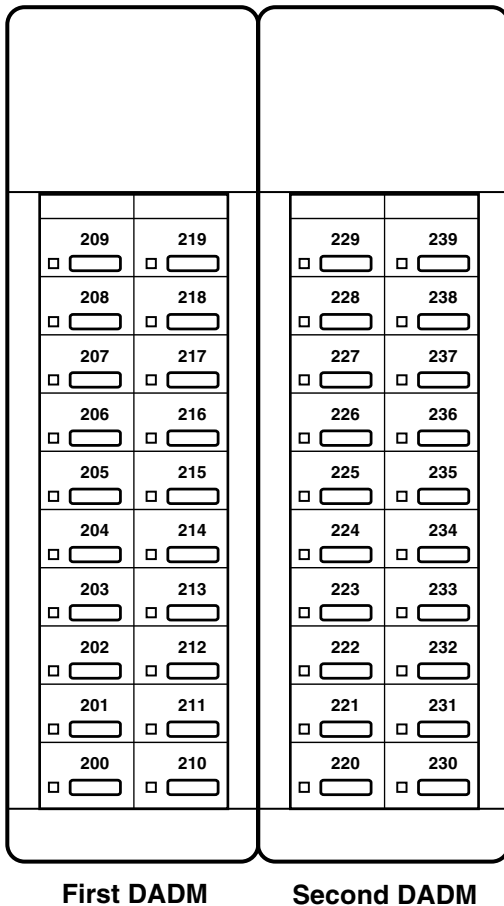

Notes

- The button numbers shown in this figure are examples only and may not reflect the numbers on your particular station equipment.
- Not available on DK14 systems.

Figure 10 Example Button Assignments for the Strata DK DADMs

DSS Console

The DSS console operates alongside of a digital telephone to provide the telephone with 60 additional feature buttons. The buttons can be programmed for [DSS], CO line access, All Call Page, Night Transfer, and Station or System Speed Dial. This guide applies to the DSS Console models DDSS2060 (see [Figure 11](#)), DDSS1060, and HDSS6560.

LEDs on the DDSS2060 and DDSS1060 models light or flash red or green, and LEDs on the HDSS6560 model light or flash red. For the DDSS2060 and DDSS1060 models, the Line (CO) and [DSS] LEDs act in the same manner as on the DADM; other feature button LEDs on both of these models will be red when activated.

TOSHIBA					
209 <input type="checkbox"/> <input type="checkbox"/>	219 <input type="checkbox"/> <input type="checkbox"/>	229 <input type="checkbox"/> <input type="checkbox"/>	239 <input type="checkbox"/> <input type="checkbox"/>	249 <input type="checkbox"/> <input type="checkbox"/>	NT <input type="checkbox"/> <input type="checkbox"/>
208 <input type="checkbox"/> <input type="checkbox"/>	218 <input type="checkbox"/> <input type="checkbox"/>	228 <input type="checkbox"/> <input type="checkbox"/>	238 <input type="checkbox"/> <input type="checkbox"/>	248 <input type="checkbox"/> <input type="checkbox"/>	AC <input type="checkbox"/> <input type="checkbox"/>
207 <input type="checkbox"/> <input type="checkbox"/>	217 <input type="checkbox"/> <input type="checkbox"/>	227 <input type="checkbox"/> <input type="checkbox"/>	237 <input type="checkbox"/> <input type="checkbox"/>	247 <input type="checkbox"/> <input type="checkbox"/>	257 <input type="checkbox"/> <input type="checkbox"/>
206 <input type="checkbox"/> <input type="checkbox"/>	216 <input type="checkbox"/> <input type="checkbox"/>	226 <input type="checkbox"/> <input type="checkbox"/>	236 <input type="checkbox"/> <input type="checkbox"/>	246 <input type="checkbox"/> <input type="checkbox"/>	256 <input type="checkbox"/> <input type="checkbox"/>
205 <input type="checkbox"/> <input type="checkbox"/>	215 <input type="checkbox"/> <input type="checkbox"/>	225 <input type="checkbox"/> <input type="checkbox"/>	235 <input type="checkbox"/> <input type="checkbox"/>	245 <input type="checkbox"/> <input type="checkbox"/>	255 <input type="checkbox"/> <input type="checkbox"/>
204 <input type="checkbox"/> <input type="checkbox"/>	214 <input type="checkbox"/> <input type="checkbox"/>	224 <input type="checkbox"/> <input type="checkbox"/>	234 <input type="checkbox"/> <input type="checkbox"/>	244 <input type="checkbox"/> <input type="checkbox"/>	254 <input type="checkbox"/> <input type="checkbox"/>
203 <input type="checkbox"/> <input type="checkbox"/>	213 <input type="checkbox"/> <input type="checkbox"/>	223 <input type="checkbox"/> <input type="checkbox"/>	233 <input type="checkbox"/> <input type="checkbox"/>	243 <input type="checkbox"/> <input type="checkbox"/>	253 <input type="checkbox"/> <input type="checkbox"/>
202 <input type="checkbox"/> <input type="checkbox"/>	212 <input type="checkbox"/> <input type="checkbox"/>	221 <input type="checkbox"/> <input type="checkbox"/>	232 <input type="checkbox"/> <input type="checkbox"/>	242 <input type="checkbox"/> <input type="checkbox"/>	252 <input type="checkbox"/> <input type="checkbox"/>
201 <input type="checkbox"/> <input type="checkbox"/>	211 <input type="checkbox"/> <input type="checkbox"/>	221 <input type="checkbox"/> <input type="checkbox"/>	231 <input type="checkbox"/> <input type="checkbox"/>	241 <input type="checkbox"/> <input type="checkbox"/>	251 <input type="checkbox"/> <input type="checkbox"/>
200 <input type="checkbox"/> <input type="checkbox"/>	210 <input type="checkbox"/> <input type="checkbox"/>	220 <input type="checkbox"/> <input type="checkbox"/>	230 <input type="checkbox"/> <input type="checkbox"/>	240 <input type="checkbox"/> <input type="checkbox"/>	250 <input type="checkbox"/> <input type="checkbox"/>

Notes

- The button numbers shown in this figure are examples only and may not reflect the numbers on your particular station equipment.
- Not available on DK14 systems.

Figure 11 Example Button Assignments (DDSS2060 shown)

[DSS] Button

The Direct Station Select [DSS] button can appear on both the DADM and DSS Console. Each DSS button is associated with a particular station in your telephone system. It can be used to transfer an outside call to the associated station or to make a direct call to the associated station. The [DSS] LED lights steady red when the station associated with the [DSS] is ringing, busy on a call, or in the DND mode; or when the associated station is idle, but all appearances of the station's [PDN] are busy or in-use by other stations. [DSS] buttons cannot call station [PhDNs], Distributed Hunt Group [DNs], or ACD Groups.

Features

The LED color indications described in these feature descriptions apply specifically to the DADM and DSS Console models DDSS2060 and DDSS1060. Flash conditions described here apply to all DSS console models and the DADM.

Calling a Station

To call a station's [PDN] from either a DSS console or a DADM, press the [DSS] associated with the station. A station call with a [DSS] can be made on-hook or off-hook, and with Voice First or Tone signaling. After pressing the button, treat the call like any other station call made from a digital telephone.

[DSS] LEDs indicate whether the associated station is idle or busy. The LED is steady red if the station is busy or ringing, and is not lit if idle. If all the station's PDN buttons are being used by other stations, the DSS LED of the station is lit steady red, but the station may be idle. If the station is in the DND mode, its DSS LED lights steady red.

Transfer to an Idle Station

You can transfer internal or outside calls to an idle station from either a DSS console or a DADM.

► **To transfer a call to an idle station**

1. Press [DSS] corresponding to the station to be called.	The call is placed automatically on hold. The Line or [DN] LED flashes green at double the on-hold rate, and the [DSS] LED flashes green.
2. Announce the call.	You hear a single-ring tone. (If using the Tone signaling mode, you hear successive ring tones.) With Tone signaling, you would have to wait for the called station to answer before announcing the call.
3. Hang up.	The call rings the called station when you hang up. While the called station is ringing, the [DSS] LED is steady red, and the Line LED flashes green at the on-hold rate or if on a [DN] button, it goes idle. When the called station answers the call, the [DSS] LED stays steady red, and the Line LED becomes steady red.
4. If the station does not answer before a period set in system programming, the call recalls your station.	

Call Transfer with Camp-on

You can transfer a call to a busy station from either a DSS console or an DADM. Use the [DSS] to transfer the call, even though the [DSS] LED associated with the station you are “transferring to” is red.

► **To transfer call to a busy station**

1. Press [DSS] corresponding to the busy station to be called.	You may hear a busy tone. The original caller is placed automatically on hold. The Line or [DN] LED flashes green at double the on-hold rate, and the [DSS] LED remains steady red.
--	---

2. Hang up.

The call rings the called station once with the camp-on tone. While the called station is receiving this tone, the Line LED flashes green (on-hold rate) or if you are on a [DN] button, it goes idle. The [DSS] LED remains steady red.

When the called station answers the transferred call, the Line LED becomes steady red. The [DSS] LED remains steady red.

Note If the busy station is in the DND mode, the call will not transfer, but will recall your telephone immediately.

If the call is not answered after a specified Recall time set in system programming, camp-on is cancelled and the transferred call rings back.

Call Answering (CO Line)

If your DADM or DSS console is equipped with a **Line** button, you can answer CO line calls from the DADM or DSS console as you would from a digital telephone. See [Chapter 2 – Features](#) for detailed information.

► To answer an incoming CO Line call to a DADM or DSS Console

- Press the flashing **Line**.

Speed Dial

Your DADM or DSS console may be equipped with **SD** (Speed Dial) buttons that can be programmed to dial telephone numbers or to access features. **SD** buttons on either the DADM or DSS console function like **SD** buttons on digital telephones. See [Chapter 2 – Features](#) for information.

Paging

You can make an announcement page to a group of station telephone speakers selected in system programming with **All Call Page** on the DSS console. **SD** (if programmed) on either the DSS console or the DADM can be used for page announcements. See “[All Call Page](#)” on Page 66.

Call Forward Override ([DSS] Override)

Either the DSS buttons on your DSS console or the associated telephone can be set in system programming to ring stations that are in the Call Forward mode, instead of being forwarded. Usually the console’s telephone is the unit activated to perform this function. Among other applications, this feature can be used to notify a person who forgets to deactivate the Call Forward feature after returning to the office.

Important! *DSS buttons on DADMs cannot override Call Forward.*

➤ To override call forward with the console’s associated telephone

1. Press **Cnf/Trn** or [PDN].
2. Dial the station number set for call forward.

Make the call as you would from any other station. This procedure assumes your station has a typical program setting.

➤ To override call forward with your DSS Console

- Press the station [DSS] set for call forward.

Night Transfer

You can use the DSS console to make the system ring different telephones for incoming calls during different times of the day. For further details, refer to the *Strata DK System Administrator’s User Guide*.

➤ To enable/disable night transfer

- Press **Night Transfer** to toggle night transfer ON/OFF.

Add-on Module/DSS Console

Features

This appendix contains access codes for outside Speed Dial numbers, CO lines, Paging Group and Paging Zone Codes.

CO Line Access Codes

CO lines are used when you dial an outside number. If your telephone does not have a **CO** or **Line** button, you can enter the appropriate code listed in [Table 13](#) to access an outside line.

You can also store the code on a Speed Dial (**SD**) button for one-touch access. If you are storing a CO line access code onto a Speed Dial code, enter **44** before the CO access code (e.g., to store code **7001**, enter **447001**).

In some systems, **9** is used as a general group code or to access Least Cost Routing (LCR). System users are required to dial **9** in order to access an outside line. If you press **9** in a system programmed with LCR, you may not hear internal dial tone, depending on system programming.

See your System Administrator for the code which applies to your telephone.

- ▶ **To access a line**
 - ▶ Press [PDN] + CO Line Access Code

Table 13 CO Line Access Codes

System	CO Line Access Codes
DK14	9 or 801~804 or #7001~#7004
DK16e/DK16	9 or 801~808 or #7001~#7008
DK40i/DK40	9 or 801~808 or #7001~#7012
DK424 (RCTUA)	9 or 801~808 or #7001~#7016
DK424 (RCTUBA/BB) and DK424i (B1CU)	9 or 801~808 or #7001~#7048
DK424 (RCTUC/D) and DK424i (B2CAU/B2CBU) (B3CAU/B3CBU)	9 or 801~816 or #7001~#7144
DK424 (RCTUE/F) and DK424i (B5CAU/B5CBU)	9 or 801~816 or #7001~#7200

Notes

- ◆ **9** accesses LCR or a general line group.
- ◆ **801~816** accesses line groups 1~16, respectively.
- ◆ **#7001~#7200** accesses individual lines 1~200, respectively.

Feature Access Codes

See [Table 7 on Page 73](#).

Paging Access Codes

Your telephone can be assigned to page group(s). Telephones can be a member of more than one group and each group can have as many as 120 stations. Station users can access each group separately by dialing an access code ([Tables 14~15](#)).

- **To enter a paging group access code**
 - Press **[PDN] + Access Code**

Table 14 Paging Groups

Paging Group	Access Code	Paging Group	Access Code
Station Group A	#311	Station Group E	#315
Station Group B	#312	Station Group F	#316
Station Group C	#313	Station Group G	#317
Station Group D	#314	Station Group H	#318

Table 15 External Paging Zones

External Paging Zone	Access Code	External Paging Zone	Access Code
DK14/DK40/DK40i/DK424/DK424i (all processors)			
Paging All Call Page Zone	#30	Paging All Call, External Page Zone	#39
DK40i/DK40/DK424 (RCTUA, RCTUBA/BB, RCTUC/D) and DK424i (B1CU, B2CAU/B2CBU, B3CAU/B3CBU)			
Zone A	#35	Zone C	#37
Zone B	#36	Zone D	#38
DK424 (RCTUE/F) and DK424i (B5CAU/B5CBU)			
Zone A	#351	Zone E	#355
Zone B	#352	Zone F	#356
Zone C	#353	Zone G	#357
Zone D	#354	Zone H	#358

Speed Dial Access Codes

The number of station and system speed dial numbers available to you depends on the size of your company's telephone system. Check with your System Administrator to find out which codes apply to your system.

Once you store a telephone number on any of the codes listed below, you can dial the number by entering the code, such as ***10** or **Speed Dial + 10**.

Table 16 Speed Dial Access Codes

Telephone System Size	Station Speed Dial Codes	System Speed Dial Codes
Small System (DK14/DK16/DK16e/DK40/DK40i/DK424 RCTUA)	10~49	60~99
Medium System (RCTUBA/BB, RCTUC/D, B1CU, B2CAU/B2CBU and B3CAU/B3CBU)	10~49	600~699
Large System (RCTUE/F and B5CAU/B5CBU)	100~139	200~999

Table 17 Speed Dial Number Linking

System	System Speed Dial Codes that can be Linked to other Speed Dial Codes
DK14, DK16e, DK40i, RCTUA	90~99
RCTUBA/BB, RCTUC/D, B1CAU, B2CAU/B2CBU and B3CAU/B3CBU	690~699
RCTUE/F and B5CAU/B5CBU	990~999

Your system may be equipped with the Centrex Application, which enhances its feature capability when installed behind a Centrex or PBX system. Your telephone may have access to one or more of the enhanced Centrex features listed below:

Flexible Directory Numbering

A station's [PDN] can be three or four digits. It is, therefore, possible to match a station's [PDN] and Centrex line extension number. Dial the entire station number when indicated.

Note Some access code numbers may have been changed to avoid system numbering plan conflicts.

Centrex Feature Buttons

You can access some Centrex features by pressing a preprogrammed flexible button on your telephone, instead of dialing a Centrex access code. The Centrex access code, including the necessary flash and/or pause sequence, is activated when the button is pressed. See your Centrex or PBX operations manual for specific details.

Ringling Repeat

The distinctive ring patterns available in your Centrex system are automatically repeated with your digital telephone, enabling you to answer appropriately for either outside, inside or callback calls.

Delayed Ringling

CO or Centrex line(s) can be programmed for a 12-second and/or 24-second ring delay at stations to permit alternate answering conditions. Answer the line when your telephone is ringling.

Button Labels

C

All flexible buttons must be programmed for your telephone in system programming and vary for individual telephones. If a button does not appear on your display or telephone keystrip label, see your System Administrator for button assignments.

The button labels in [Table 18](#) are for the 2000-series telephone mode.

Table 18 Feature Button Definitions

2000-series Telephone	Definitions
Account Code	Account Code Button Press to enter a Voluntary Account Code anytime during a Central Office (CO) line call without interrupting the conversation.
Alarm Reset	Alarm Reset Button Press to turn off a telephone alarm connected to a facility alarm mechanism.
Alert Signal (1, 2, 3, or 4)	Alert Signaling Buttons Press to alert a predesignated station with a distinctive sound and to indicate a pre-arranged meaning and visual indication to a predesignated station. Up to four Alert Signal buttons can be assigned to a telephone.
All Call Page	All Call Voice Page Button Press to page all of the digital and electronic telephones in the All Call Page group.
Auto Busy Redial	Automatic Busy Redial Button Press to set up Automatic Busy Redial after receiving a busy tone on a dialed CO line call (not available when calling on tie or DID CO lines).

Table 18 Feature Button Definitions *(continued)*

2000-series Telephone	Definitions
Auto Callback	Automatic Callback Button Press to recall a busy station or station in the Do Not Disturb (DND) mode as soon as that station becomes idle or deactivates DND. Also used for CO line queuing when all lines are busy.
Call Frwd All Calls	Call Forward-All Calls Button Press to forward all calls to another station or voice mail device.
Call Frwd Busy	Call Forward-Busy Button Press to forward calls immediately to another station or voice mail device when your station is busy or in the DND mode.
Call Frwd Busy NAns	Call Forward-Busy/No Answer Button Press to forward calls immediately to another station or voice mail device when your station is busy or in DND mode. Also forwards calls when your station is not answered after 8~60 seconds (set at your station).
Call Frwd No Answer	Call Forward-No Answer Button Press to forward calls to another station or voice mail device when your station is not answered after 8~60 seconds (set at your station).
Call Frwd External	Call Forward-External Button Press to forward Private or DID line calls to an external or internal telephone number.
Call Frwd to	Call Forward-Fixed Button Press to forward all calls to a station or voice mail device assigned in system programming.
Data Release	Data Release Button Press to release data calls. See the Strata DK PC/Data Interface User Guide.
Directed Pickup	Call Pickup Button Press to initiate a ringing Directed Call Pickup of CO line, [DN], and page calls.
Directed Pickup (1, 2, 3, or 4)	Tenant Call Pickup Buttons If the system is shared by tenants, the Directed Pickup 1~4 buttons pick up ringing CO line calls for Tenants 1~4 respectively.
Do Not Disturb	Do Not Disturb Button Press to lock your station in or out of the DND mode.

Table 18 Feature Button Definitions (continued)

2000-series Telephone	Definitions
DSS	Direct Station Selection Button(s) Press to ring a preselected station. The LED associated with each DSS button provides the status (idle/busy) of the station assigned to the button.
Flash	Flash Button Press to perform the following functions: Disconnect and recall dial tone on a CO line; access Centrex or PBX features; enter a pause or flash signal when programming speed dial numbers.
Group Pickup	Group Pickup Button Press to pick up a call that is ringing a station that belongs to a Pickup Group that your station is a member of.
HS OCA Talkback	Handset Off-hook Call Announce Button Press this key while off-hook busy with a call and while being called by an internal caller who initiates off-hook call announce to switch the talk path from the current call to the off-hook call announce internal caller.
LCD Msg Select	Message Select Button Press to enable system and personal messages to be displayed on the optional 32-character LCD.
Line	Line Button Press to answer or access an outside Central Office (CO) line.
Lost Call Auto Dial	Unanswered (Lost) Call Automatic Dial Button Press to automatically dial the stored ANI (Automatic Number Identification) or Caller ID number shown on the LCD. Unanswered calls will be stored on this button and the LCD.
Microphn Cut-off	Microphone Cutoff Button Press to turn the microphone off/on while idle, providing privacy when you receive handsfree internal calls. Also functional when your station receives calls—the Mic button controls the microphone when you originate calls.
Modem	Modem Button Press to reserve a modem from a pool. The LED of the button indicates the status of the modem pool. See the Strata DK PC/Data Interface User Guide.
Msg Wait	Additional Message Waiting Buttons Phantom Directory Numbers allow multiple Message Waiting buttons with LEDs for up to four different Directory Numbers [DNs] other than your Primary Directory Number [PDN]. It performs the same Message Waiting functions as the MW/FL button.

Table 18 Feature Button Definitions *(continued)*

2000-series Telephone	Definitions
Night Transfer	Night Transfer Button Press to control the system's CO line ringing pattern for after-hours incoming calls.
Night Transfer (1~4)	Tenant Night Transfer Buttons Press the appropriate button to control the system's CO line ringing patterns for after hours incoming calls for either of the tenants that share a single Strata DK280 system.
NT Lock (1~4)	Night Transfer Lock Buttons Initiates entry of the NT Lock password. NT L LED will be on when the system ring mode (Day/Day2/Night) is locked.
Orbit List	Park Orbit Display Button - LCD Telephones Only Press to display call(s) parked in orbit. If there are multiple parked calls, a + sign appears on the LCD.
Park and Page	Park/Page Button Press to park internal or outside call in orbit and announce to other telephones or paging speakers to retrieve the parked calls.
Park in Orbit	Park Button Press to park internal or outside calls in an orbit. Call retrieval can be made locally from the same parking telephone or remotely from a different telephone.
Pooled Line Grp	Pooled Line Button Press to access an available CO line from a group of lines appearing under one button.
Privacy on Line	Privacy Button Press to block Privacy Override on common CO line buttons. This button does not block Busy Override or Executive Override.
Privacy Release	Privacy Release Button Press to release privacy on common CO line buttons, enabling other station users to enter your conversations on those buttons. Privacy release does not apply to common [DN] buttons which are always private.
Release and Ans	Release and Answer Button Press to disconnect or complete the transfer the current CO or [DN] call and automatically answer the new incoming CO or [DN] call.

Table 18 Feature Button Definitions (continued)

2000-series Telephone	Definitions
Release Call	Release Button Press to disconnect or complete the transfer of the current CO or [DN] call and to place your station in the idle condition.
Save Last Number	Save Button After dialing an outside or internal directory number, press to “save” the number. Later, you can have the system automatically redial the number for you when you press the button after accessing an internal or outside line.
SD or Customized Button	Speed Dial Button Press to Speed Dial a telephone number or feature access codes. SD buttons can be used as either System Speed Dial numbers or Station Speed Dial numbers.
Speed Dial	Speed Dial Select Button Press (in conjunction with Redial) to store and access Speed Dial number.
Spd Dial Lng Pause	Pause (Long) Button Press to insert a 10-second pause when programming Speed Dial numbers.
Spd Dial Pause	Pause Button Press to set either a one-half or two-second pause when programming Speed Dial numbers. (The pause time is set in system programming).
Start	Start Button Press to make an outgoing call using an ISDN trunk.
Sub	Subaddress Button Press to enter a subaddress on an ISDN trunk outgoing call.
Tel Set Music	Background Music Button Press to turn Background Music on or off over your station speaker.
Tone Dial Select	Tone Button Press to change the outgoing dialing of the CO line in use from dial pulse to tone signaling.
Unlock Door	Door Lock Buttons Press to unlock a door lock mechanism.

Add-on Module/DSS Console



Delayed Ringing

The DKT2000 V.4 series telephones have DIP switches that enable use for the international market. The DIP switches are located underneath the flexible button key strip on the DKT2000 V.4 series telephones (see [Figure 4](#)).

[Table 19](#) shows the correct country settings for the DKT2010-S, DKT2020-S, DKT2010-SD, DKT2020-SD, DKT2020-FDSP, DKT2001 V.4 telephones.

Note The default DIP switch settings are preset for the USA and Canada. Therefore, you do not need to adjust any of these from the default factory settings for North America.

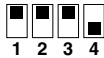
Table 19 DKT International DIP Switch Settings

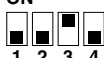
Country	Dip Switch				DIP Switch Position
	1	2	3	4	
USA Canada (Default Setting)	ON	ON	ON	ON	ON  1 2 3 4
Mexico	ON	ON	ON	OFF	ON  1 2 3 4
Taiwan	OFF	ON	ON	ON	ON  1 2 3 4
Hong Kong Thailand ¹	ON	OFF	ON	ON	ON  1 2 3 4
Singapore Malaysia Indonesia Sri Lanka India China	OFF	OFF	ON	OFF	ON  1 2 3 4

3925

1. The DKT2000 V.4 is not compatible for Hong Kong and Thailand. Use the V.4A or later versions in these two countries.

Index

A

about this book
 conventions, [ix](#)
 how to use this guide, [viii](#)
 organization, [viii](#)
 related documents, [x](#)

ABR, [23](#)

ACB, [25](#)

access code
 using, [29](#)

access codes, [133](#)
 CO Line, [133](#)
 feature, [72](#)
 speed dial, [136](#)

account code
 calls, [20](#)
 emergency override of forced account
 codes, [20](#)
 forced account codes (verified/non-
 verified), [20](#)

add-on module/DSS console, [125](#)

advisory messaging, [105](#)

alert signaling, [22](#)

all call page, [66](#)

ANI/Caller ID, [97](#)

attendant console calling, [23](#)

auto dial lost calls, [99](#)

automatic busy redial, [23](#)

automatic callback, [25](#)

automatic hold, [26](#)

B

before you begin, [15](#)

BGM over telephone speakers, [27](#)

BLF display, [96](#)

busy override, [64](#)

button labels, [139](#)

buttons, [4](#)
 [DSS], [128](#)
 [PDN], [7](#)
 [PhDN], [7](#)
 [SDN], [7](#)
 Cnf/Trn, [4](#)
 directory number, [7](#)
 feature, [8](#)
 fixed, [4](#)
 flexible, [6](#)
 Hold, [4](#)
 LCD, [9](#)
 Mic, [5](#)
 Mode, [90](#)
 Msg, [5](#)
 Page, [91](#)
 Redial, [5](#)

Scroll, 91
Spkr, 6
volume control, 4, 6

C

call forward, 27
 all calls, 30
 busy/no answer, 32
 external, 34
 fixed, 33
 modes, 28
 no answer, 31
 to voice systems, 87
 using the buttons, 29
call park
 orbit list display, 99
 orbits, 36
call pickup, 40
 directed, 40
call transfer, 42
 with camp-on, 42
call waiting, 44
called station messaging, 107
Caller ID/ANI/DNIS information mode, 97
centrex application, 137
centrex feature buttons, 137
Cnf/Trn, 4
CO Line access codes, 133
conference calls, 45
control buttons, 90

D

DADM, 125
date/time/day adjustment, 46
delayed ringing, 138
digital add-on module (DADM), 125
digital telephone models
 (see telephone models)

direct inward system access, 46
direct station selection buttons, 48
directed call pickup, 40
directory number, 7
DISA, 46

 incoming calls, 46
 outgoing calls, 47

DKT2010-H, 2
DKT2010-SD, 2
DKT2020-FDSP, 2, 117
DKT2020-S, 2
DKT2020-SD, 2

DNIS, 97
do not disturb (DND), 48
do not disturb override, 64
door lock, 49
door phone, 50
[DSS] button, 128
DSS, 48
 console, 125, 127

E

emergency override of forced account
codes, 20
emergency ringdown, 53, 57
executive override, 64
exit from any mode, 91

F

feature access codes, 72
feature buttons, 8
features, 128
 call answering (CO Line), 130
 call forward override ([DSS]
 Override), 131
 call transfer with camp-on, 129
 calling a station, 128
 night transfer, 131

- paging, 131
- speed dial, 130
- transfer to an idle station, 128

flash, 75

flexible buttons, 6

flexible directory numbering, 137

forced account codes (verified/non-verified), 20

full-duplex speakerphone, 117

G

group called station messaging, 108

group listening, 53

group pickup, 41, 42

- calls to other groups, 41
- calls within your group, 41

H

handsfree answerback, 54

handsfree monitoring, 55

Hold, 4

hotline service

- emergency ringdown, 53, 57

I

incoming DISA calls, 46

indicators

- LED, 10

ISDN

- buttons, 18, 56, 80, 143
- feature codes, 73

L

LCD, 9

- buttons, 9
- how to enter characters, 101
- messages, 103

- operation, 89
- telephones, 29
 - incoming calls, 30
 - outgoing call, 29

LED indicators, 10

liquid crystal display (LCD), 9

lost calls

- retrieve and auto dial, 99

M

memo, 111

- speed dial, 111
- timed reminders, 113

message, 103

- advisory, 105
- called station, 107
- group called station, 108
- notifications, 107
- remote calling station, 106
- silent (busy station), 110
- station, 104
- system, 104

message waiting light

- on [PDN], 57
- on [PhDN/MW], 59
- on another telephone, 59

messages, memos, and name display, 101

Mic, 5

microphone cut-off, 60

mode button, 90

Msg, 5

N

name/number display, 56, 113

O

OCA, 60

- off-hook, 11
- off-hook call announce, 60
- on-hook, 11
- outgoing DISA calls, 47
- override
 - busy, 64
 - do not disturb, 64
 - executive, 64
 - privacy, 65
 - toll restriction, 65
- override calls, 63

P

- page announcements, 66
- page button, 91
- paging group codes, 134
- phantom directory number, 7
- primary directory number, 7
- privacy
 - on-line, 67
 - override, 65

Q

- quick reference, 17

R

- redial, 5
- release and answer, 68
- remote calling station messaging, 106
- remote destination change, 35
- retrieve and auto dial lost calls, 99
- ringing repeat, 138

S

- saved number redial, 68
- scroll button, 91
- secondary directory number, 7

- silent messaging (busy station), 110
- soft keys, 91
 - display, 92
 - how to use, 92
 - making a conference call (example), 93
 - prompts, 95
- speakerphone, 69
- speed dial, 70
 - access codes, 136
 - advanced features, 72
 - chain dialing, 77
 - linked speed dial example, 76
 - number linking, 75
 - pause and flash storage, 75
 - long pause, 75
 - memos, 111
 - pause, 75
- Spkr, 6
- SP-OCA, 62
- start (ISDN button), 18, 56
- sub (subaddress ISDN button), 56

T

- telephone models
- timed reminders, 78
- toll restriction override, 65
- tone/pulse dialing, 80
- two (tandem) CO line connection, 80
 - [DN], 80
 - CO buttons, 81
 - supervision, 83

U

- using access codes, 29

V

- voice mail integration, 84

- message mailbox, [84](#)
- message retrieval, [85](#)
- multiple message retrieval, [86](#)
- volume, [4](#), [6](#)
- volume controls, [12](#)
- voluntary account codes (verified/non-verified), [21](#)

